

sigma[®]

Made in Italy *di Ambrogiani*

Attrezzature professionali per piastrellisti
Professional tools for tilers

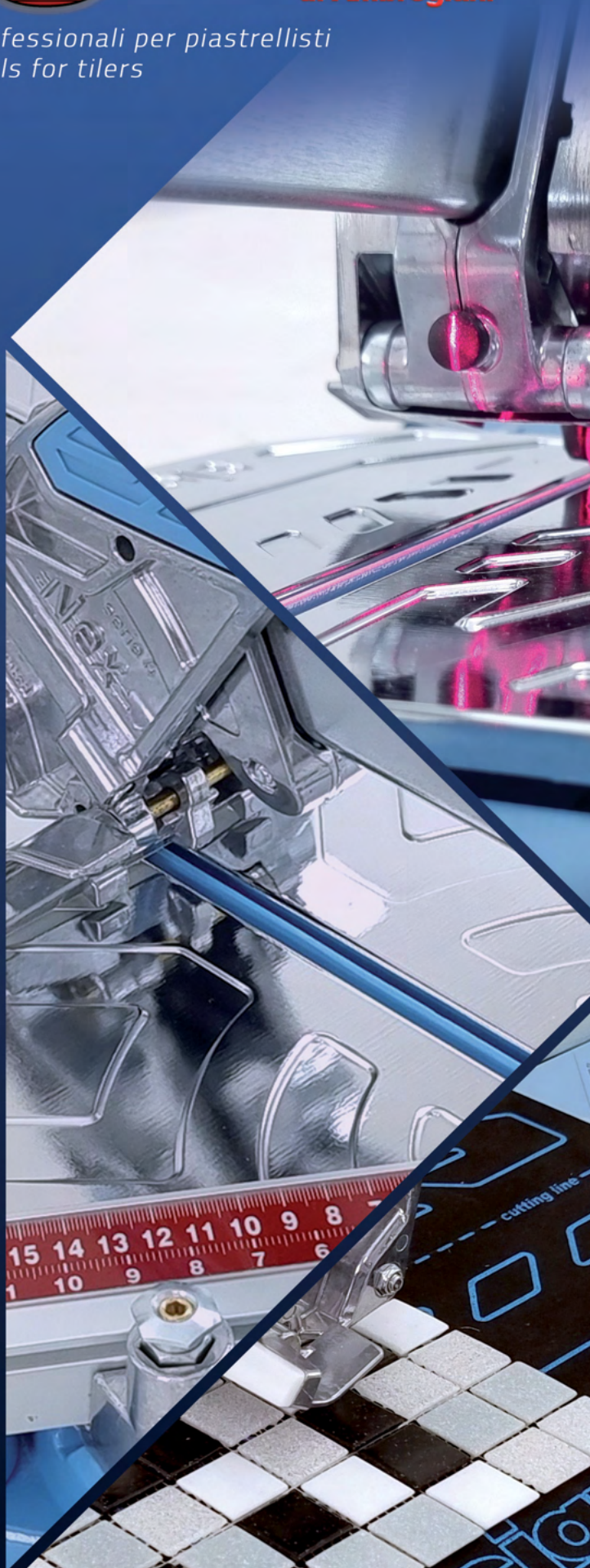



PRICE LIST
LISTINO PREZZI

2023-2024

	L'azienda The company		6
	Taglia piastrelle SERIE 4 : Caratteristiche Tile cutters SERIE 4 : Features	NEW	8
62-161 cm. 	Serie 4 Nex Taglia piastrelle Tile cutters	NEW	10
70-103 cm. 	Serie 4 Up Taglia piastrelle Tile cutters	NEW	14
	Optionals Serie 4	NEW	18
205-245 cm. 	Serie XL Taglia piastrelle Tile cutters		20
37-55 cm. 	Taglia piastrelle a Trazione Tile cutters to Pull		22
61-66 cm. 	Serie Tecnica Taglia piastrelle Tile cutters		24
151-382 cm. 	Kera-Cut Sistema di taglio Cutting system		28

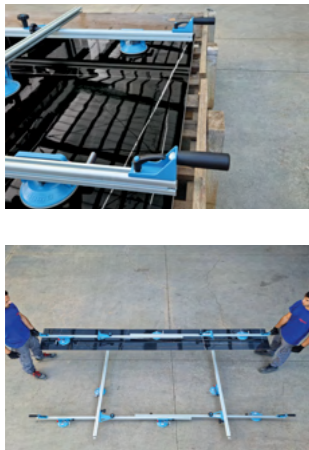
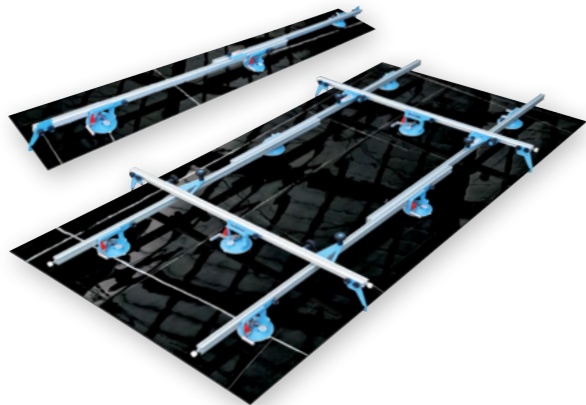
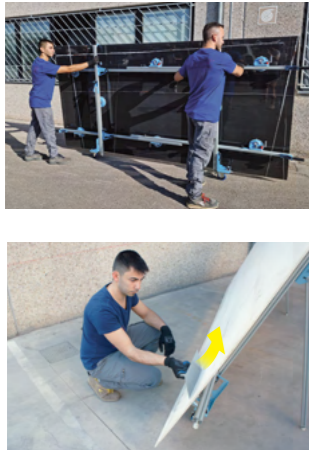
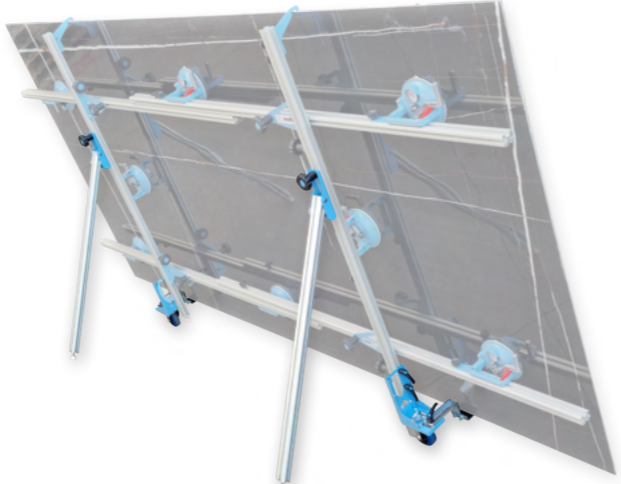
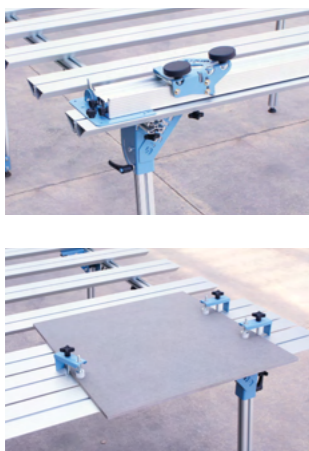
100-450 cm. 	Banco da lavoro Workbench		32
100-340 cm. 	Kera-Lift Attrezzature per la movimentazione di grandi formati Handling tools for large format	NEW	36
	J-Pro per Jolly precisi for Miter	NEW	40
	Jolly Edge per Jolly precisi e mezzo Toro for Miter and half Bullnose		42
	Simple Bevel per smussi precisi for accurate bevels		44
100-300 mm. 	Mole e Dischi diamantati Diamond Grinding Wheels and Discs	NEW	46
6-70 mm. 	Frese diamantate Diamond Drill Bits	NEW	50
	Utensili per incollaggio Gluing Tools		52
	Accessori Tiling Accessories		54

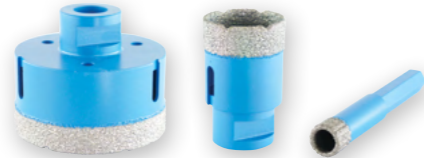
		<p>Kera-Lift Attrezzature per la movimentazione di grandi formati Handling tools for large format</p>	<p>36</p>	<p>NEW</p>
		<p>Kit Carrello per Kera-Lift Carriage Kit for Kera-Lift</p>	<p>38</p>	
		<p>Banco da lavoro Workbench</p>	<p>32</p>	
		<p>Frese Diamantate Diamond Drill Bits NEW</p>	<p>50</p>	

		<p>Kera-Cut Sistema di taglio manuale Manual cutting system</p>	<p>28</p>	
		<p>Kera-Flex Sistema di taglio elettrico Electric cutting system</p>	<p>31</p>	
		<p>J-Pro per Jolly precisi for Miter</p>	<p>NEW</p>	<p>40</p>
		<p>Jolly Edge per Jolly precisi e mezzo Toro for Miter and half Bullnose</p>	<p>42</p>	
		<p>Simple Bevel per biselli precisi for accurate bevels</p>	<p>44</p>	
		<p>Utensili per incollaggio Gluing Tools</p>	<p>52</p>	

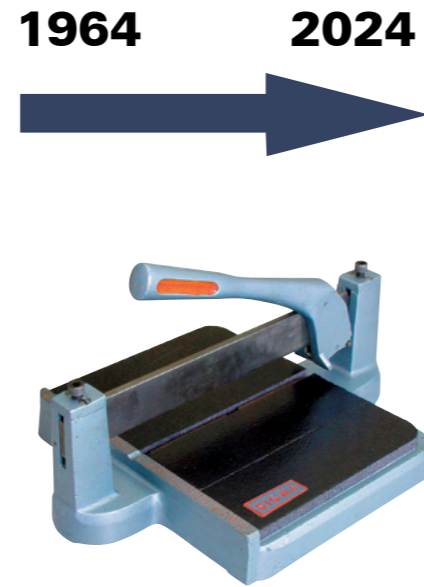

La nostra azienda, nata nel 1964, è specializzata nella produzione di attrezzatura per i piastrellisti e opera in base alle specifiche e mutevoli esigenze degli operatori professionali.

La realizzazione di prodotti di qualità ha determinato, negli anni, lo sviluppo costante sui mercati nazionali e internazionali.

La progettazione viene effettuata interamente dai nostri tecnici interni utilizzando programmi CAD 3D.

La nostra produzione viene eseguita con processi di lavorazione codificati, scanditi con collaudi in ogni sua fase.

Le prove e i test da noi effettuati, dapprima sui prototipi e poi sulle macchine in produzione, consentono di garantire la realizzazione di un prodotto finito che risponda agli alti standard di qualità, sicurezza e robustezza richiesti, sempre nel rispetto delle attuali normative europee.

Our company, founded in 1964, specializes in the production of equipment for tilers and operates according to the specific and changing needs of professional operators.

The creation of quality products has determined, over the years, our constant development on the national and international markets.

All our design works are carried out entirely by our internal technicians using 3D CAD programs.

Our production is executed with codified manufacturing processes, punctuated with testing at every stage.

The trials and tests carried out by us, first on the prototypes and then on the machines in production, allow us to guarantee the creation of a finished product that meets the high standards of quality, safety and strength required, always in compliance with current European regulations.





Impugnature ergonomiche con scorrimento completamente su cuscinetti a sfera.

Ergonomic handle that slides completely on ball bearings.

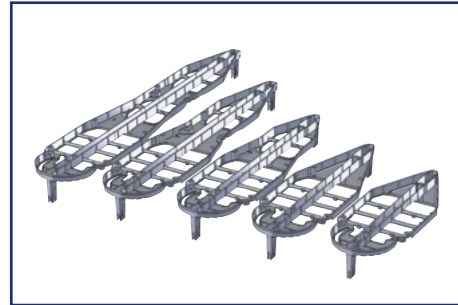

La struttura in alluminio, ottenuta da una unica fusione per massima robustezza e leggerezza.

The aluminum structure, obtained from a single fusion for maximum strength and lightness.



Valigie con ruote.

Case with wheels.



Tappetino magnetico antiscivolo per taglio mosaico.

Non-slip magnetic mat for mosaic cut.

Ingombro ridotto per il trasporto.
Reduced volume for transport.

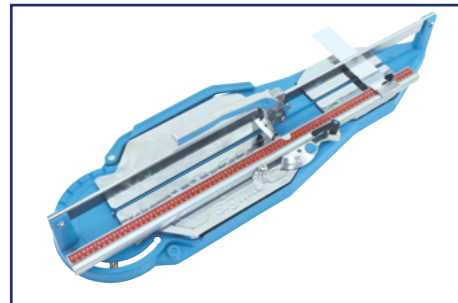

Supporti molleggiati, apribili per il sostegno di grandi piastrelle.

Spring-loaded support brackets, which can be opened to support large tiles.

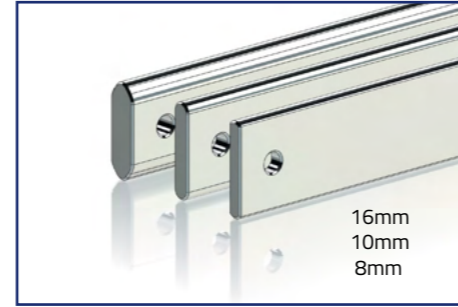

Guide di scorrimento, molto robuste per una incisione perfettamente rettilinea.

Sliding guides, very sturdy for perfect straight scoring.



Predisposizione per montaggio LASER di posizionamento (Disponibile 09/2023)

Predisposition for LASER guide. (Available 09/2023)



Barra metrica con angolazione e misurazione sempre vicina all'operatore.

Metric bar with angle and measurement always close to the operator.



Barra metrica fulcrata su perno di acciaio in centro alla linea di taglio, orientabile +45° 0° - 45°.

The measurement bar pivots on a steel pin at the centre of the cutting line, swiveling at +45° 0° - 45°.



Tasto regolabile, per il posizionamento rapido della barra metrica alle angolazioni più usate.

Adjustable stop for the quick positioning of metric bar on the angles most commonly used.

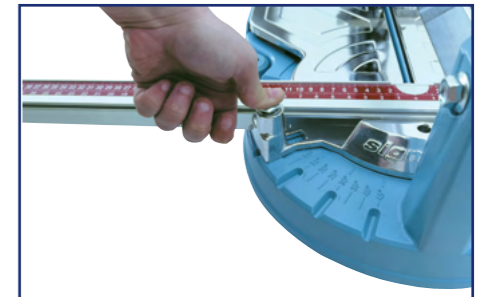

Righetta metrica con misura del lato e della diagonale

Metric scale with side and diagonal measure.

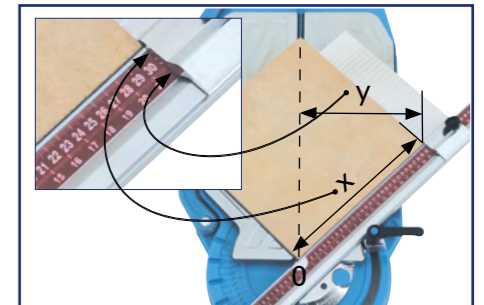

Prolunga per barra metrica orientabile fissabile alla estremità destra o sinistra.

Extension for adjustable metric bar fixable at the right or left end.

Lungo squadretto di appoggio posizionabile vicino alla linea di taglio.

Long support square that can be positioned close to the cutting line.

Misura anteriore 410 - 0 - 410 mm
Front measure 410 - 0 - 410 mm

Contenitore per ricambio rotella di incisione.
Spare scoring wheel compartment.

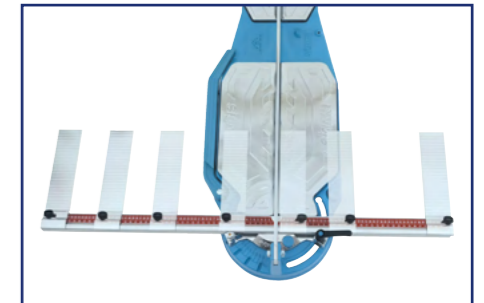
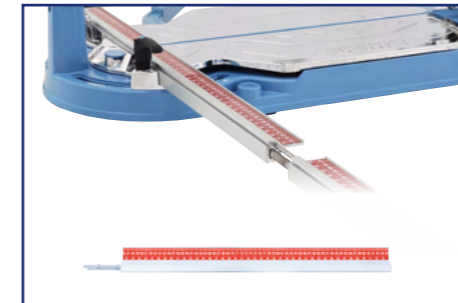
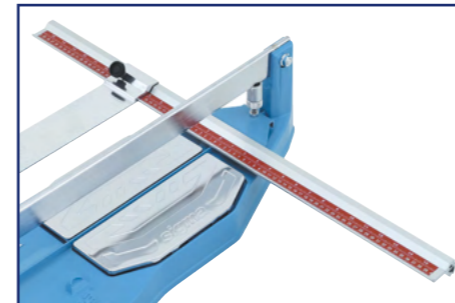

Incisione a spinta , facile e profonda
Pushing incision, easy and deep

Serie 4 "NEX"
 Struttura irrigidita per un'ottima fase d'incisione / spacco.
 Scorrimento delle impugnature completamente su cuscinetti a sfera in acciaio, incisione perfetta e rettilinea nel tempo.
 Barra goniometrica con vano porta rotella, estensibile con prolunga (Art.17A).
 Nuovo fissaggio della barra goniometrica con perno in acciaio, diminuisce l'usura e mantiene la precisione nel tempo.

Serie 4 "NEX"
 Rigid structure which allows an excellent scoring and splitting phase.
 Sliding of the handle entirely on steel ball bearings, perfect scoring, straight over time.
 Swivel measurement bar with spare scoring wheel compartment, extendable through extension (item 17A).
 New fixing of the measurement bar with a steel pin reduces wear and maintains precision over time.

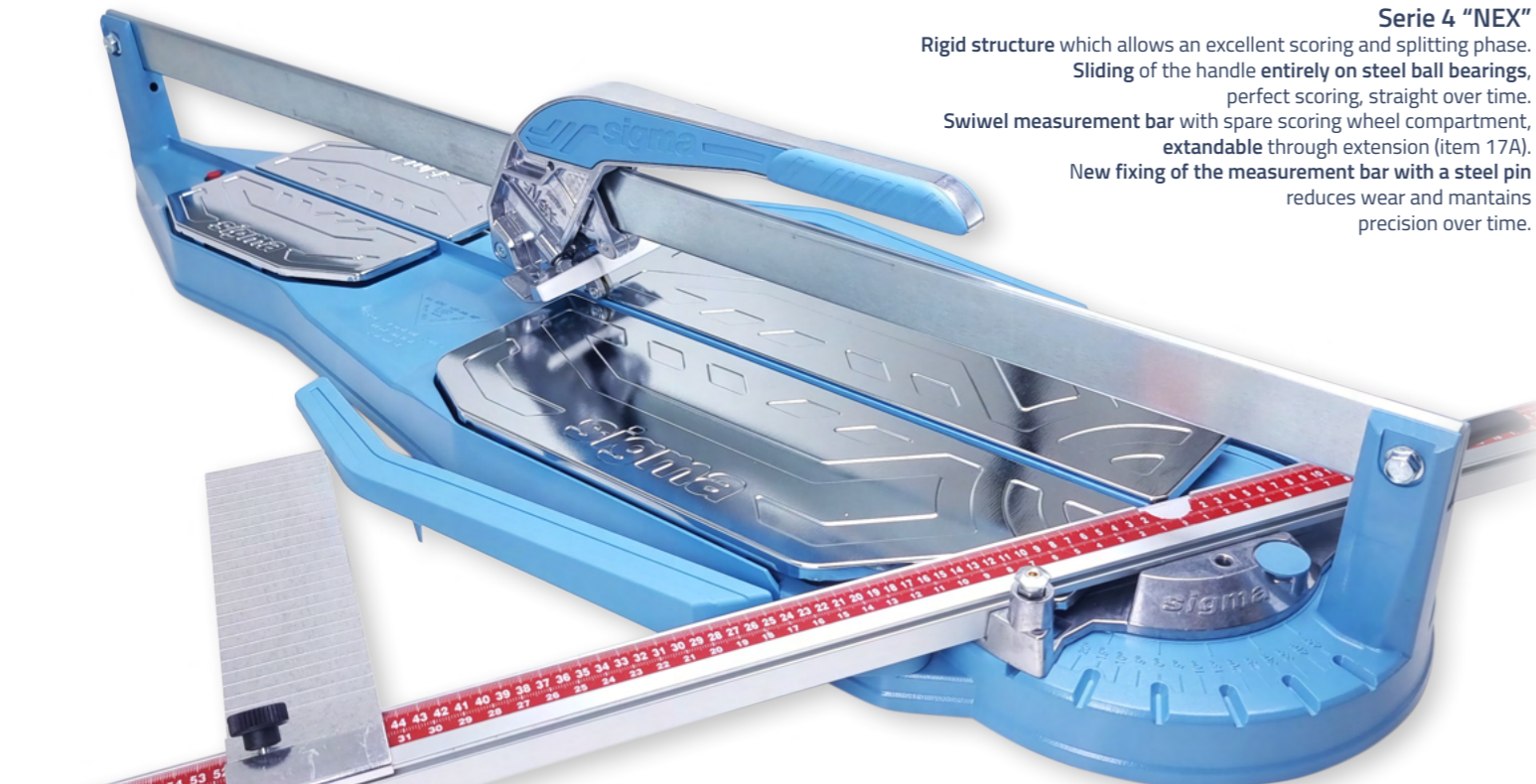

NEW

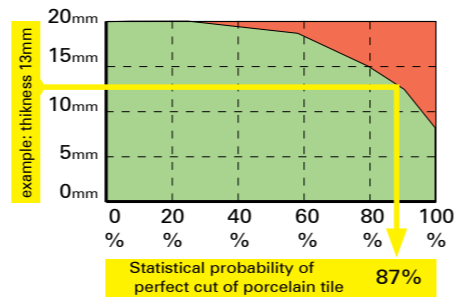

Reference patents: 212181 - 1330295 - 1274856 - 1353486 - 1624742 - 1279735 - 3526-0001 - 4021900000184 - 102021000008660 - 402021000009950 - 202021000001775 - 202021000001778
 Some have a corresponding international patent:
 U202230593 - 17/715,212 - P202230322 U202230597 - U202230595 - DM/221639 DM/221331 DM221639 - 202212045 - 202212046 202212047 202230194724.X - S014.D3.CN4 DIV1 - S014.D3.CN4 DIV2 - 202230408029.9 202230407899.4

Art.									
4BN	62 cm 24,4"	43,8 cm 17,2"	0-19 mm 3/4"	1200 Kg.	10,5 Kg.	1 pz. 13,4 Kg.	102 x 48 x 31cm	12 pz.	
4CN	76 cm 29,9"	53,7 cm 21,1"	0-19 mm 3/4"	1200 Kg.	12,6 Kg.	1 pz. 15,6 Kg.	116 x 48 x 31cm	12 pz.	
4DN	95 cm 37,4"	67,2 cm 26,4"	0-19 mm 3/4"	1200 Kg.	14,9 Kg.	1 pz. 18,0 Kg.	135 x 48 x 31cm	12 pz.	
4EN	125 cm 49,2"	88,4 cm 34,8"	0-19 mm 3/4"	1200 Kg.	22,3 Kg.	1 pz. 25,6 Kg.	166 x 48 x 31cm	8 pz.	
4FN	155 cm 61,0"	109,6 cm 43,1"	0-19 mm 3/4"	1200 Kg.	26,3 Kg.	1 pz. 29,8 Kg.	196 x 48 x 31cm	8 pz.	
Girando l'impugnatura aumenta di 6 cm la lunghezza di taglio.				Turning the handle increases the cutting length by 6 cm.					

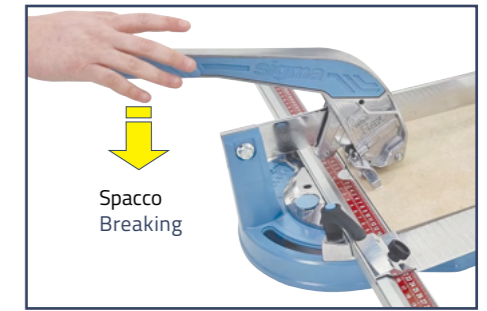
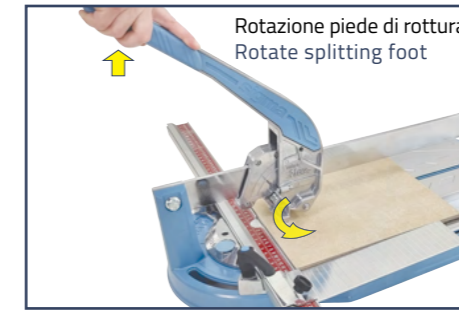
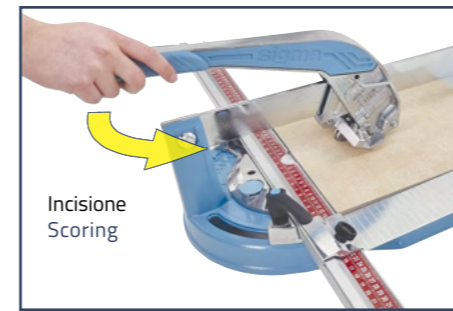

La rotella di incisione è disponibile anche nella versione rivestita TIN.
 The scoring wheel is also available with a TIN coat.

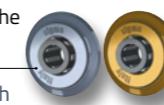

Compensatore automatico in acciaio per la regolazione del precarico di scorrimento del carrello sulla guida.

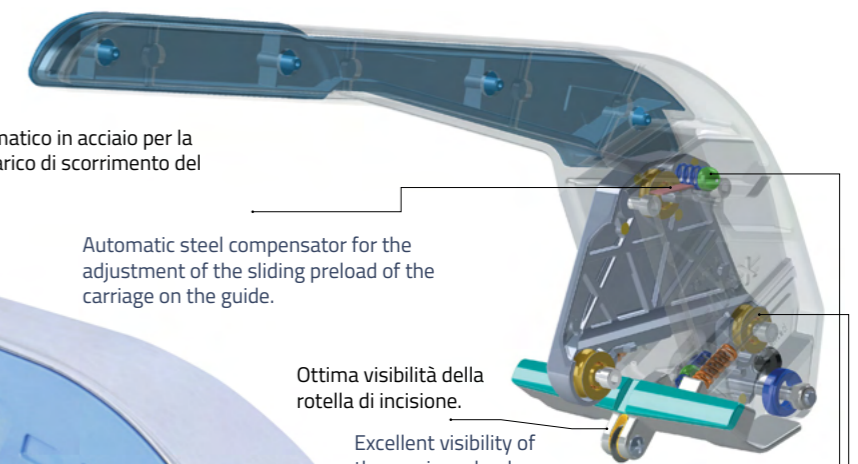

Impugnatura di forma ergonomica, specifica per incisione a spinta.

Ergonomic handle, specific for push scoring.

Protezione antisegno intercambiabile.

Interchangeable anti-sign protection.

Doppio molleggio per incisione ammortizzata di piastrelle strutturate.

Double spring system for cushioned scoring on structured tiles.

Piede di spacco largo 120mm.

120mm large splitting foot.

Ammortizzatore di fine incisione.

Shock absorber at the end of the scoring.

Un sistema automatico tiene sollevata l'impugnatura per favorire l'inserimento della piastrella.

An automatic system holds the handle raised to ease the positioning of the tile.

Il carrello di scorrimento della impugnatura è privo di usura, grazie a 3 cuscinetti a doppia corona di sfere che garantiscono precisione nel tempo, senza necessità di manutenzione.

The sliding carriage of the handle is wear-free, thanks to 3 double crown ball bearings that guarantee precision over time, without the need for maintenance.

L'impugnatura è accoppiata al carrello di scorrimento con due cuscinetti reggispinta a sfere, per la massima precisione.

The handle is coupled to the sliding carriage with two thrust bearing ball bearings, for maximum precision.

La rotella di incisione ruota su cuscinetto a rulli ed è guidata lateralmente da un guscio in metallo antifrizione inserito in un alloggiamento fresato CNC, per evitare attriti e usura laterale.

The scoring wheel rotates on a roller bearing and is guided laterally by an anti-friction metal shell inserted in a CNC milled housing, to avoid friction and lateral wear.

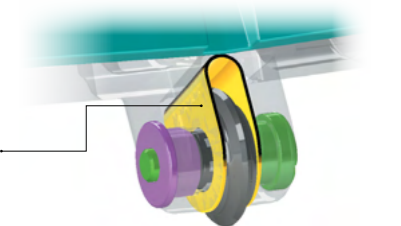

Art. 4BN cm.62

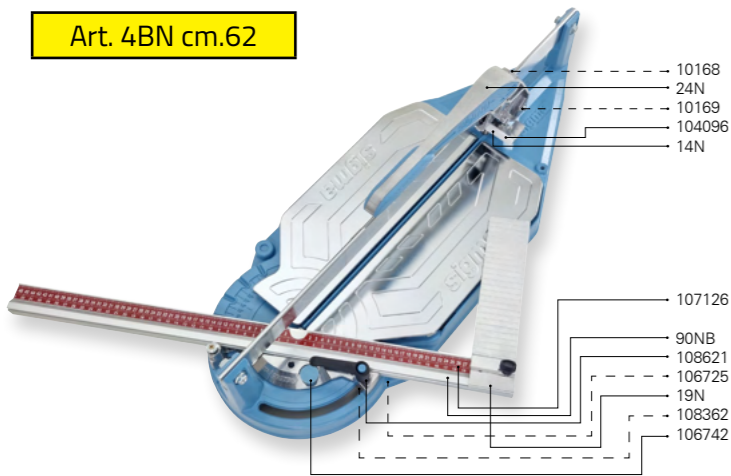

Art. 4CN cm.76

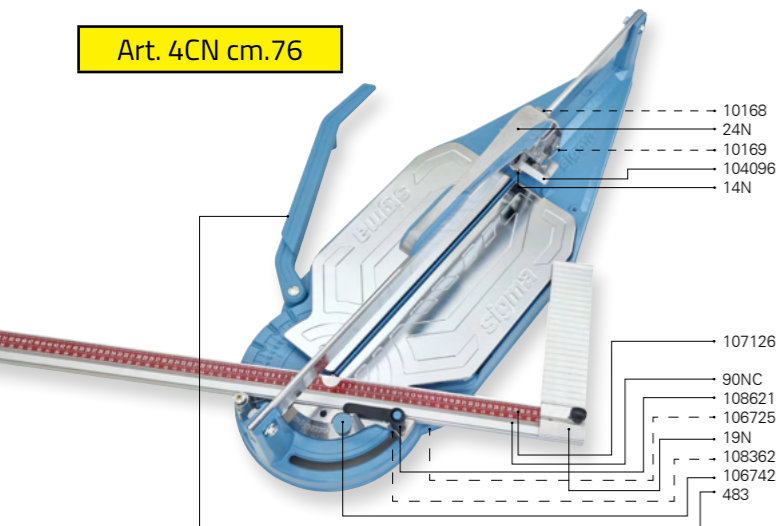

Art. 4DN cm.95

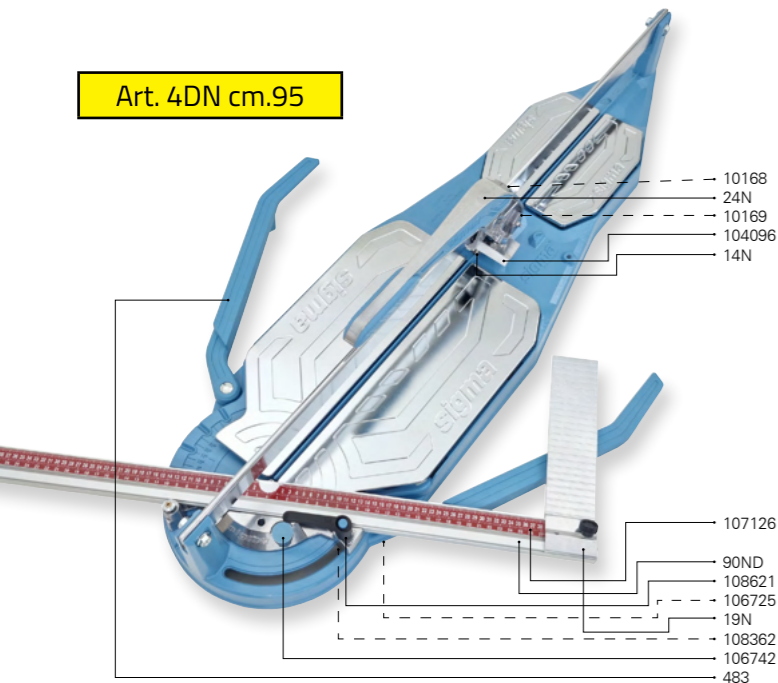

Art. 4EN cm.125

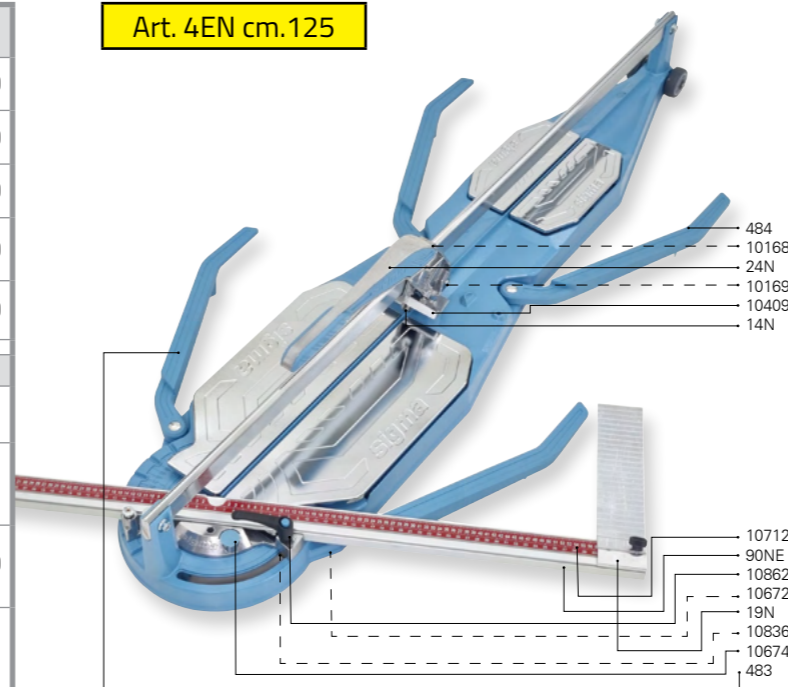

Art. 4FN cm.155

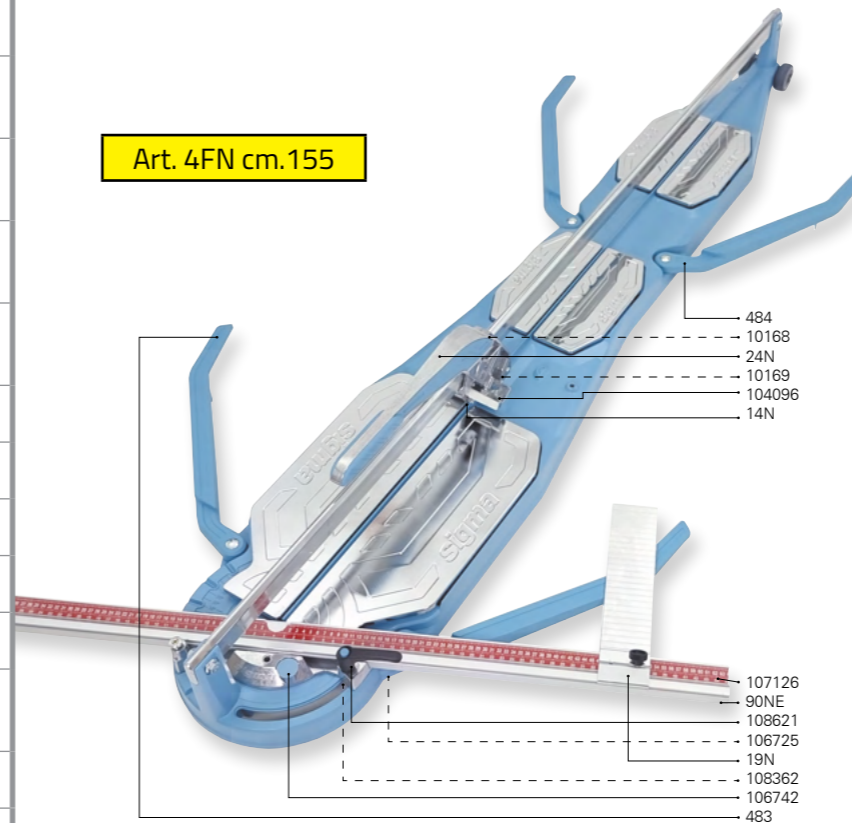

Art.	Descrizione	Description		Euro
4BN	TAGLIA PIASTRELLE cm.62	TILE CUTTER cm. 62	1	365,00
4CN	TAGLIA PIASTRELLE cm. 76	TILE CUTTER cm. 76	1	405,00
4DN	TAGLIA PIASTRELLE cm. 95	TILE CUTTER cm. 95	1	472,00
4EN	TAGLIA PIASTRELLE cm.125	TILE CUTTER cm. 125	1	678,00
4FN	TAGLIA PIASTRELLE cm. 155	TILE CUTTER cm. 155	1	880,00
Ricambi		Spare parts		
14N	Rotella per incisione Ø 16 mm completa	Ø 16 mm complete scoring wheel	10	11,00
14NT	Rotella per incisione al TITANIO, Ø mm 16 completa	Ø 16 mm complete TITANIUM scoring wheel	10	13,00
24N	Impugnatura NEX a spinta, completa per SERIE 4	NEX push handle, complete for SERIE 4	1	110,00
104096	Protezione sottopiede antisegno per leva Art. 24N	NO-MARK protection for handle Art.24N	1	2,00
10168	Cuscinetto con gola r.5 Ø 5-20-8 per carrello impugnature SERIE 4	Bearing with groove r. 5 Ø 5-20-8 for SERIES 4 handles' cart	1	7,00
19N	Squadretta 260mm per SERIE 4	260mm Square for SERIE 4.	1	16,50
90NB	Barra metrica orientabile per Art. 4BN 47-0-35cm	Swivel measurement bar 47-0-35 cm for Art.4BN	1	61,00
90NC	Barra metrica orientabile per Art. 4CN 54-0-40cm	Swivel measurement bar 54-0-40 cm for Art.4CN	1	66,00
90ND	Barra metrica orientabile per Art. 4DN 64-0-46cm	Swivel measurement bar 64-0-46 cm for Art.4DN	1	72,00
90NE	Barra metrica orientabile per Art. 4EN 4FN 64-0-64cm	Swivel measurement bar 64-0-64cm for Art. 4EN 4FN	1	82,00
483	Supporto Sx completo per SERIE 4	Complete Left support for SERIE 4	1	14,00
484	Supporto Dx completo per SERIE 4	Complete Right support for SERIE 4	1	14,00
106742	Tappo contenitore per vano ricambi SERIE 4	Plug for spare parts compartment SERIE 4.	1	0,50
107126	Righetta metrica adesiva per SERIE 4	Adhesive measurement tape for SERIE 4	1	5,70
108621	Pomolo a leva M8x40 per SERIE 4	Clamping knob lever M8x40 for SERIE 4	1	5,10
108362	Dado M8 quadro 20 per Pomolo a leva SERIE 4	Nut M8 Square 20 for Clamping knob lever for SERIE 4	1	2,50
106725	Tappo piede Ø 20/25 H24 per SERIE 4	Rubber foot 20/25 H24 for SERIE 4	1	1,10
Vendita a confezioni intere		Sold in full packs only		

Descrizione - Description		Euro
Optionals	Visibili a pagina 18 Check page 18	
Art. 64B2 Tappetino magnetico antiscivolo, universale per mosaico 337x486mm		35,00
Non-slip magnetic mat, universal 337x486mm for mosaic cut.		
Art. 90E5 Misura anteriore da 410 - 0 - 410 mm per SERIE 4 + 19N (taglio utile= max - 3cm.)		93,00
Front measure from 410 - 0 - 410 mm for SERIE 4 + 19N (cut = max - 3cm.)		
Art. 17A Prolunga 500mm per barra metrica orientabile, fissabile alla estremità destra o sinistra.		43,00
500mm Extension for adjustable metric bar, fixable at the right or left end.		
Art. 022 Laser Kit per delineare la linea di taglio.		59,00
Laser kit to "Light Up" the cutting line.		
Art. 43E2 Valigia in tela imbottita con ruote per Art. 4EN - 3E		78,00
Canvas padded case with wheels for Art. 4EN - 3E		
Art. 43D2 Valigia in tela imbottita con ruote per Art. 4DN - 3D		69,00
Canvas padded case with wheels for Art. 4DN - 3D		

Incisione a trazione, pratica e veloce Pulling incision, fast and practical

Serie 4 "UP"

Struttura irrigidita per un'ottima fase d'incisione / spacco.

Scorrimento delle impugnature completamente su cuscinetti a sfera in acciaio, incisione perfetta e rettilinea nel tempo.

Barra goniometrica con vano porta rotella, estensibile con prolunga (Art.17A).

Nuovo fissaggio della barra goniometrica con perno in acciaio, diminuisce l'usura e mantiene la precisione nel tempo.

Serie 4 "UP"

Rigid structure which allows an excellent scoring and splitting phase.

Sliding of the handle entirely on steel ball bearings, perfect scoring, straight over time.

Swivel measurement bar with spare scoring wheel compartment, extendable through extension (item 17A).

New fixing of the measurement bar with a steel pin reduces wear and maintains precision over time

NEW

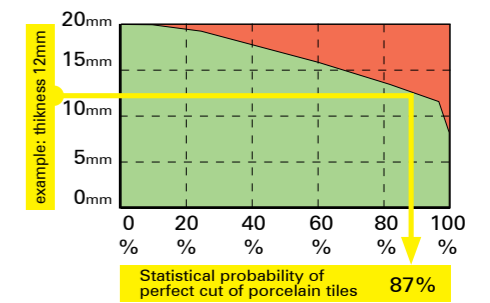
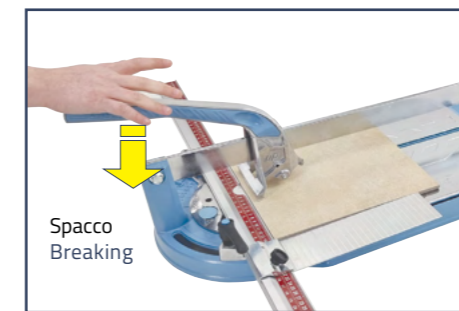

La rotella è disponibile anche nella versione rivestita TIN per una maggiore durata

The scoring wheel is also available with a TIN coat for longer life span.



Impugnatura di forma ergonomica, specifica per incisione a trazione.

Ergonomic handle, specific for pull scoring.

Compensatore automatico in acciaio per la regolazione del precarico di scorrimento del carrello sulla guida.

Automatic steel compensator for the adjustment of the sliding preload of the carriage on the guide.

Un sistema automatico tiene sollevata l'impugnatura per favorire l'inserimento della piastrella.

An automatic system holds the handle raised to ease the positioning of the tile.

Il carrello di scorrimento dell'impugnatura è privo di usura, grazie a 3 cuscinetti a doppia corona di sfere che garantiscono precisione nel tempo, senza necessità di manutenzione.

The sliding carriage of the handle is wear-free, thanks to 3 double crown ball bearings that guarantee precision over time, without the need for maintenance.

Piede di spacco largo 100mm.

100mm large splitting foot.

L'impugnatura è accoppiata al carrello di scorrimento con due cuscinetti reggispinta a sfere, per la massima precisione.

The handle is coupled to the sliding carriage with two thrust bearing ball bearings, for maximum precision.

Ottima visibilità della rotella di incisione.

Excellent visibility of the scoring wheel.

Protezione antisegno intercambiabile dotata di ammortizzatore di fine incisione.

Interchangeable stain-free protection with shock absorber at the end of the scoring.

Scavo portarotella fresato CNC e guscio in metallo antifrizione per eliminare attriti e usura laterale della rotella di incisione.

CNC milled wheel holder, roller bearing and anti-friction metal shell to erase friction and lateral wear of the scoring wheel.

Reference patents: 212181 - 1330295 - 1274856 - 1353486 - 1624742 - 1279735 - 3526-0001 - 4021900000184 - 402021000000950 - 02021000008621 - 202021000001778

Some have a corresponding international patent: U202230593 - 17/715,212 - P202230322 - U202230597 - U202230595 - DM/221639 - DM/221331 - DM221639 - 202212045 - 202212046 - 202212047 - 202230408029.9 - S014.D3.CN4 DIV1 - S014.D3.CN4 DIV2 - 202230408029.9 - 202230407899.4

Art.									
4BU	70 cm 27,5 inc	49,5 cm 19,5 inc	0-17 mm 0,66 inc	1050 Kg.	10,1 Kg.	1 pz. 13,0 Kg.	102 x 48 x 31cm	12 pz.	
4CU	84 cm 33 inc	59,4 cm 23,4 inc	0-17 mm 0,66 inc	1050 Kg.	12,2 Kg.	1 pz. 15,2 Kg.	116 x 48 x 31cm	12 pz.	
4DU	103 cm 40,5 inc	72,8 cm 28,6 inc	0-17 mm 0,66 inc	1050 Kg.	14,5 Kg.	1 pz. 17,6 Kg.	135 x 48 x 31cm	12 pz.	

Art. 4BU cm.70

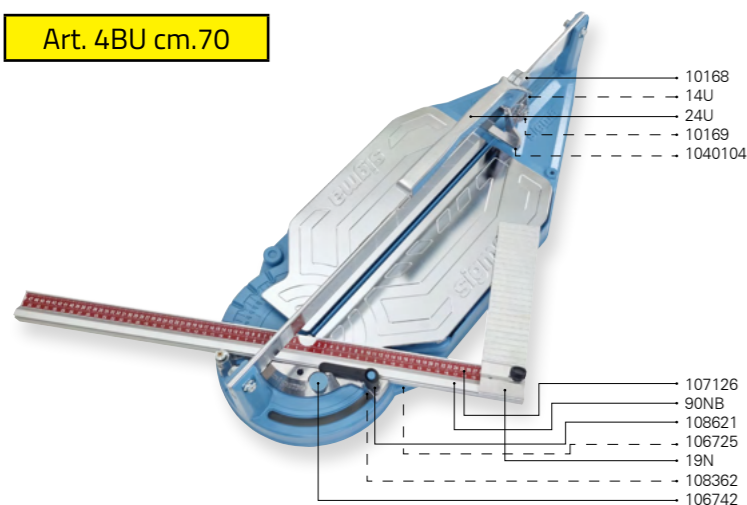

Art. 4CU cm.84

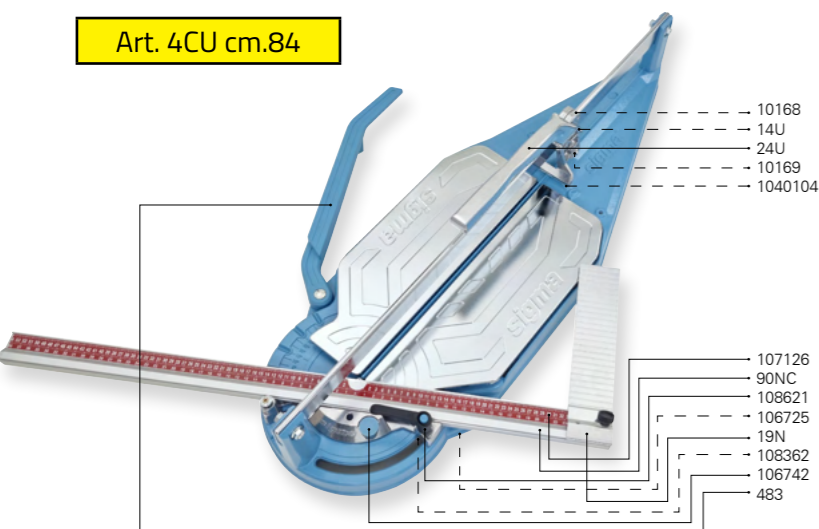

Art. 4DU cm.103

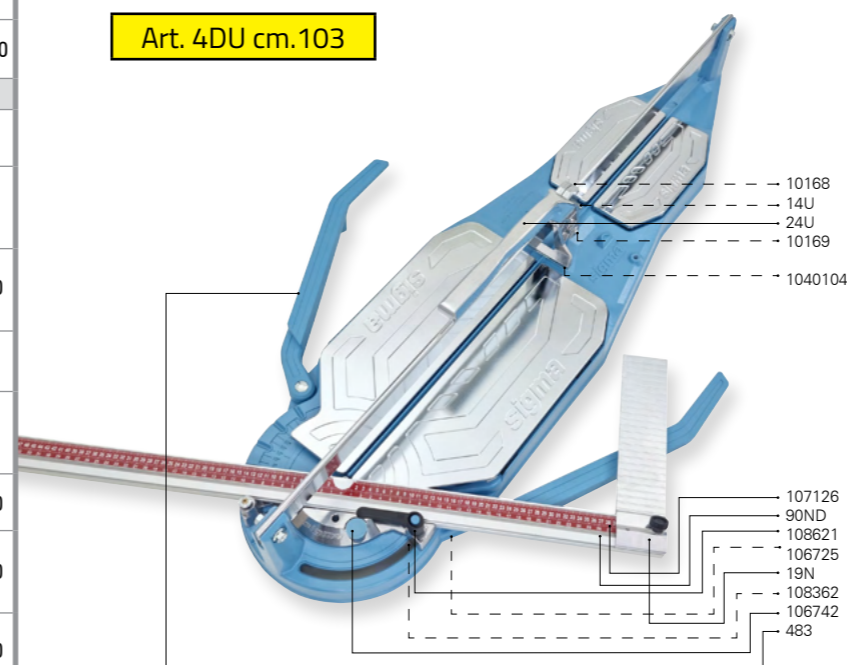

Art.	Descrizione	Description		Euro
4BU	TAGLIA PIASTRELLE cm.70	TILE CUTTER cm. 70	1	345,00
4CU	TAGLIA PIASTRELLE cm.84	TILE CUTTER cm. 84	1	385,00
4DU	TAGLIA PIASTRELLE cm.103	TILE CUTTER cm. 103	1	452,00
	Ricambi	Spare parts		
14U	Rotella per incisione Ø 12 mm completa	Ø 12 mm complete scoring wheel	20	5,80
14UT	Rotella per incisione al TITANIO, Ø mm 12 completa	Ø 12 mm complete TITANIUM scoring wheel	20	8,00
24U	Impugnatura UP a trazione, completa per SERIE 4	UP pull handle, complete for SERIE 4.	1	90,00
1040104	Protezione sottopiede antisegno per leva Art. 24U	NO-MARK protection for handle Art.24U	1	1,70
10168	Cuscinetto con gola r.5 Ø 5-20-8 per carrello impugnature SERIE 4	Bearing with groove r. 5 Ø 5-20-8 for SERIES 4 handles' cart	1	7,00
19N	Squadretta 260mm per SERIE 4	260mm Square for SERIE 4.	1	16,50
90NB	Barra metrica orientabile per Art. 4BU 47-0-35 cm	Swivel measurement bar 47-0-35 cm for Art.4BU	1	61,00
90NC	Barra metrica orientabile per Art. 4CU 54-0-40 cm	Swivel measurement bar 54-0-40 cm for Art.4CU	1	66,00
90ND	Barra metrica orientabile per Art. 4DU 64-0-46 cm	Swivel measurement bar 64-0-46 cm for Art.4DU	1	72,00
483	Supporto Sx completo per SERIE 4	Complete Left support for SERIE 4	1	14,00
484	Supporto Dx completo per SERIE 4	Complete Right support for SERIE 4	1	14,00
106742	Tappo contenitore per vano ricambi SERIE 4	Plug for spare parts compartment SERIE 4.	1	0,50
107126	Righetta metrica adesiva per SERIE 4	Adhesive measurement tape for SERIE 4	1	5,70
108621	Pomolo a leva M8x40 per SERIE 4	Clamping knob lever M8x40 for SERIE 4	1	5,10
108362	Dado M8 quadro 20 per Pomolo a leva SERIE 4	Nut M8 Square 20 for Clamping knob lever for SERIE 4	1	2,50
106725	Tappo piede Ø 20/25 H24 per SERIE 4	Rubber foot Ø 20/25 H24 for SERIE 4	1	1,10
Vendita a confezioni intere		Sold in full packs only		

Descrizione - Description		Euro
Optionals	Visibili a pagina 18 Check page 18	
Art. 64B2 Tappetino magnetico antiscivolo, universale per mosaico 337x486mm Non-slip magnetic mat, universal 337x486mm for mosaic cut.		35,00
Art. 90E5 Misura anteriore da 410 - 0 - 410 mm per SERIE 4 + 19N (taglio utile= max - 3cm.) Front measure from 410 - 0 - 410 mm for SERIE 4 + 19N (cut = max - 3cm.)		93,00
Art. 17A Prolunga 500mm per barra metrica orientabile, fissabile alla estremità destra o sinistra. 500mm Extension for adjustable metric bar, fixable at the right or left end.		43,00
Art. 022 Laser Kit per delineare la linea di taglio. Laser kit to "Light Up" the cutting line.		59,00
Art. 43D2 Valigia in tela imbottita con ruote per Art. 4DN - 3D Canvas padded case with wheels for Art. 4DN - 3D		69,00

Art. 022

NEW

Laser Kit Perfetto per delineare la linea di taglio, è possibile equipaggiarlo a tutta la "Serie 4".

Laser kit.
Perfect to "Light Up" the cutting line.
It's possible to equip it on all "Series 4" models.

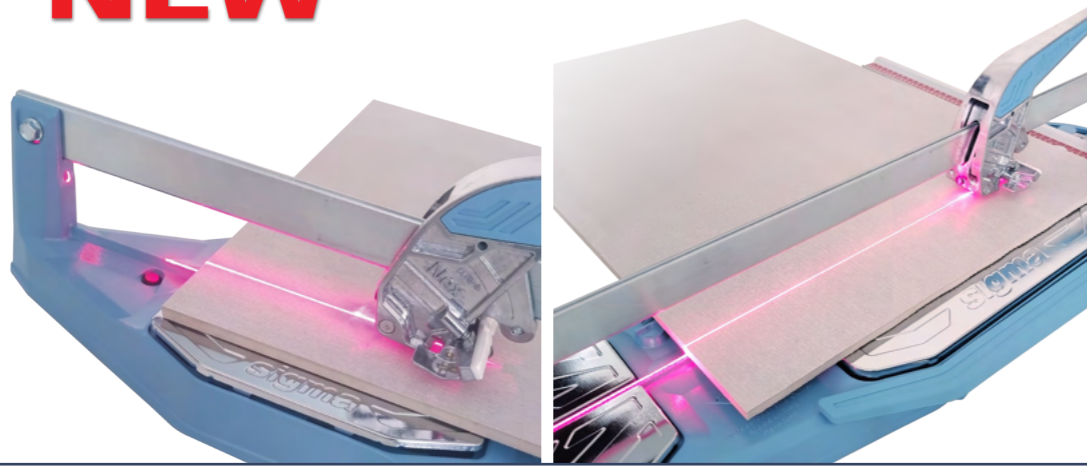

Art. 64B2

Tappetino magnetico per mosaico.
Perfetta aderenza, superficie ad alto grip e compatibile con tutta la "Serie 4".

Magnetic mat for mosaic.
Perfect adherence, a high grip surface that fits for the whole "Series 4".

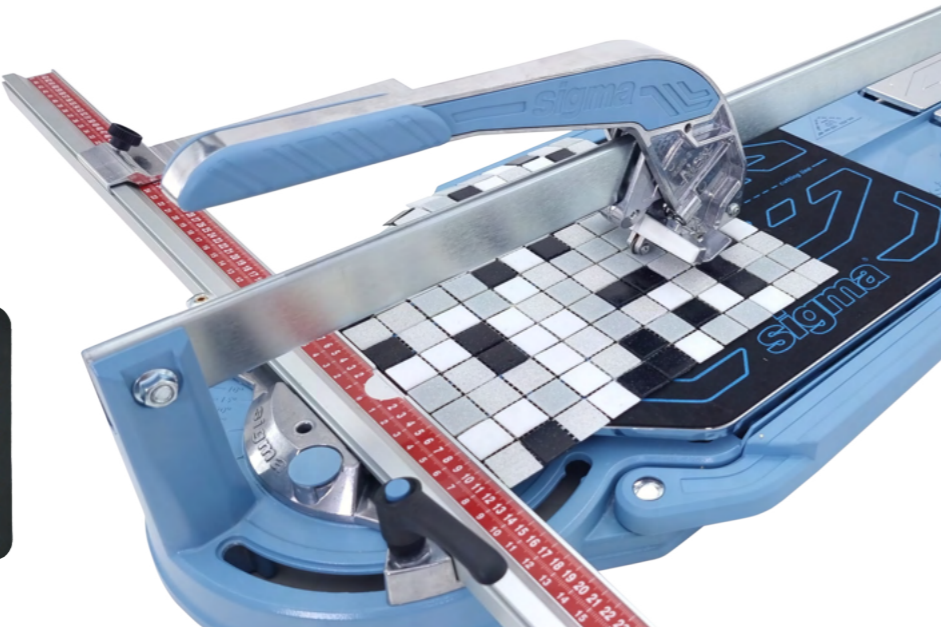
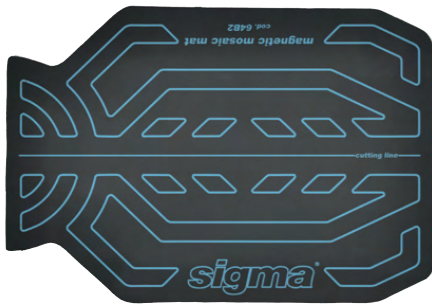

Art. 90E5

Barra metrica anteriore completa di squadretta, per tagli perfettamente paralleli, con misurazione da entrambi i lati di 40cm, compatibile con tutta la "Serie 4".

Front metric bar (square included), for perfectly parallel cuts, with 40 cm measurement from both sides of the tile cutter, compatible with the whole "Series 4".

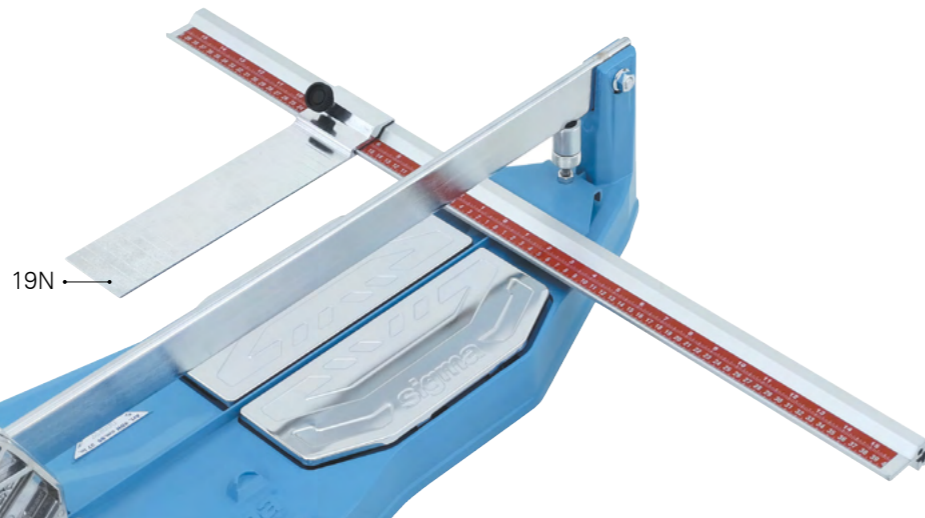

Art. 17A

Prolunga 50 cm per barra goniometrica "Serie 4", applicabile a destra o a sinistra in base alle specifiche esigenze.
Accoppiamento di precisione con inserti in acciaio.

50 cm extension for "Series 4" goniometric bar, applicable to the right or to the left according to specific needs.
Precise fit with steel inserts.

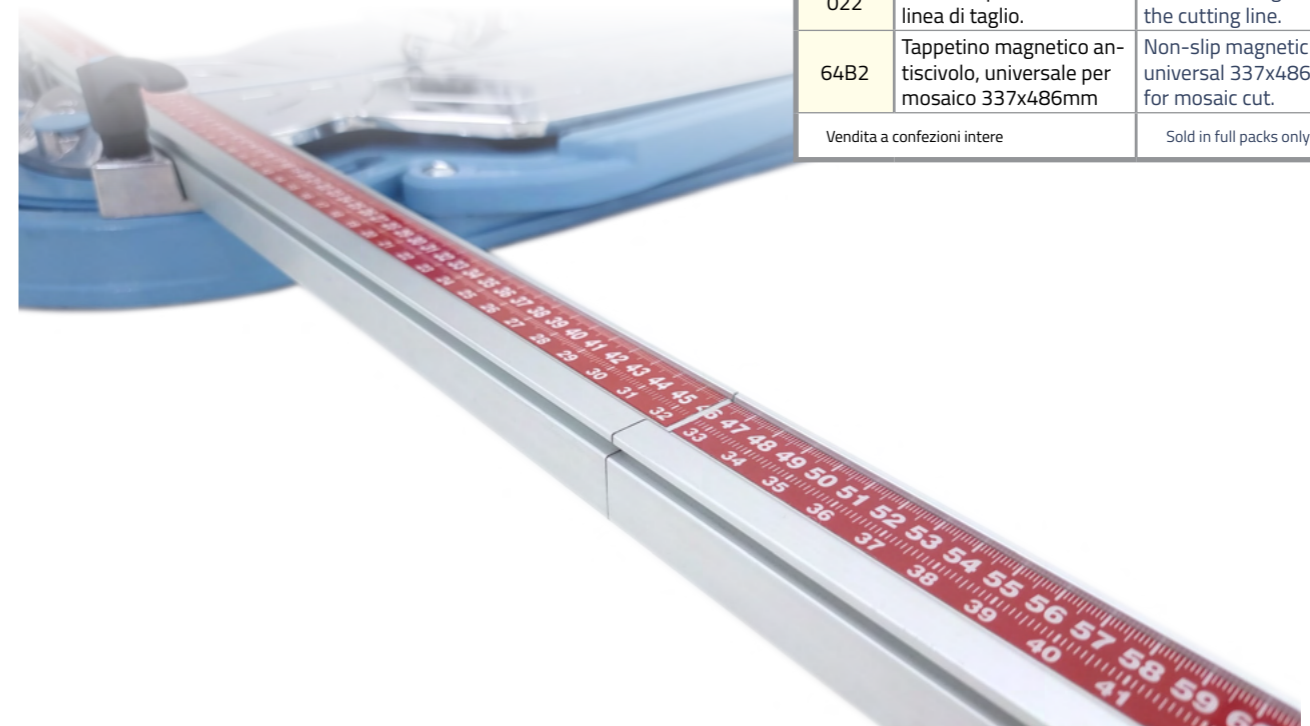

Art. 43D2

Valigia in tela imbottita con ruote per 4DU-4DN
Canvas padded case with wheels for Art. 4DU-4DN

Art. 43E2

Valigia in tela imbottita con ruote per 4EN
Canvas padded case with wheels for Art. 4EN



Art.	Descrizione	Description		Euro
	Optionals	Optionals		
017A	Prolunga 500mm per barra metrica orientabile, fissabile alla estremità destra o sinistra.	500mm Extension for adjustable metric bar, fixable at the right or left end.	1	43,00
90E5	Misura anteriore da 410 - 0 - 410 mm per SERIE 4 + 19N (taglio utile= max - 3cm.)	Front measure from 410 - 0 - 410 mm for SERIE 4 + 19N (cut = max - 3cm.)	1	93,00
43D2	Valigia in tela imbottita con ruote per Art. 4DN - 4DU - 3D	Canvas padded case with wheels for Art. 4DN - 4DU - 3D	2	69,00
43E2	Valigia in tela imbottita con ruote per Art. 4EN - 3E	Canvas padded case with wheels for Art. 4EN - 3E	2	78,00
022	Laser Kit per delineare la linea di taglio.	Laser kit to "Light Up" the cutting line.	1	59,00
64B2	Tappetino magnetico antiscivolo, universale per mosaico 337x486mm	Non-slip magnetic mat, universal 337x486mm for mosaic cut.	1	35,00
Vendita a confezioni intere		Sold in full packs only		

Tagliapiastrelle per grandi dimensioni Tile cutter for big sizes

"XL" Grande tagliapiastrelle con struttura e guida di scorrimento in lega leggera temprata e indurita. L'impugnatura con incisione a spinta ammortizzata, scorre completamente su cuscinetti a sfere e guide inox. Dotata di doppia misura per tagli paralleli e di appoggio orientabile da +45° a -45°.

"XL" Big tile cutter with frame and sliding guide made of light hardened aluminium alloy. The push handle with cushioned scoring, runs completely on ball bearings and stainless steel runners. Equipped with a double measures for parallel cuts and pivoting support from +45° to -45°.

Art.12D1 cm.205

Art.12E1 cm.245

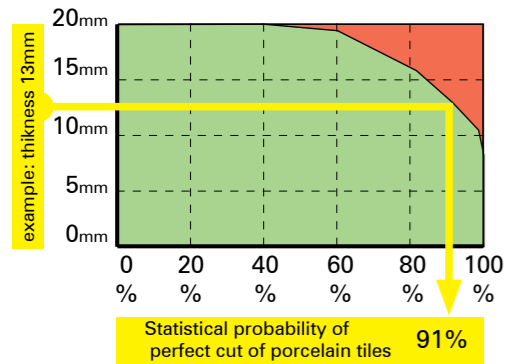
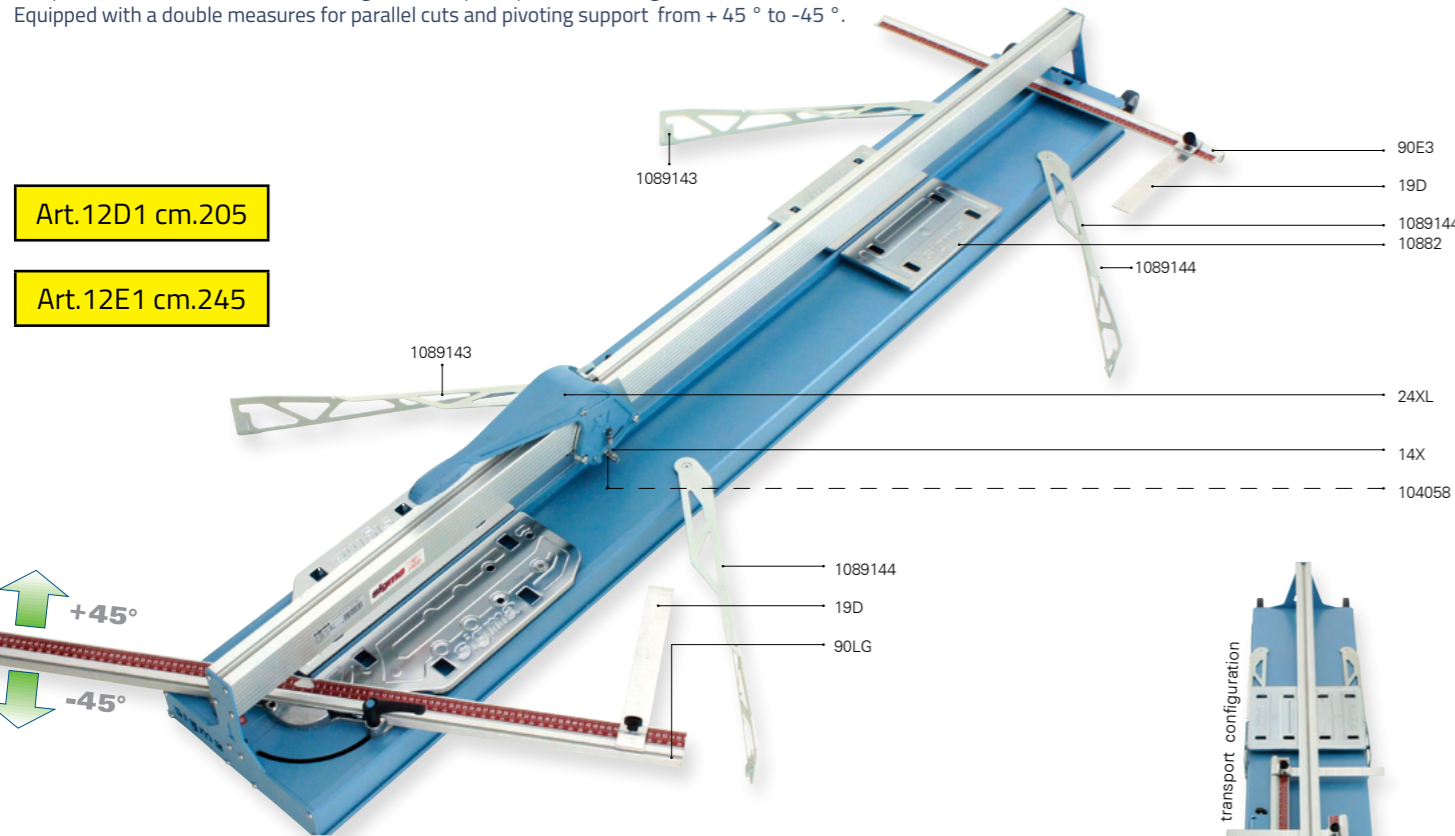

Art.									
12D1	205 cm 80,7 inc	145 cm 57,0 inc	0-19 mm 3/4 inc	770 Kg.	36 Kg.	1 pz. 40 Kg.	246 x 40 x 38 cm	10 pz.	
12E1	245 cm 96,4 inc	173 cm 68,0 inc	0-19 mm 3/4 inc	770 Kg.	39 Kg.	1 pz. 43 Kg.	286 x 40 x 38 cm	10 pz.	

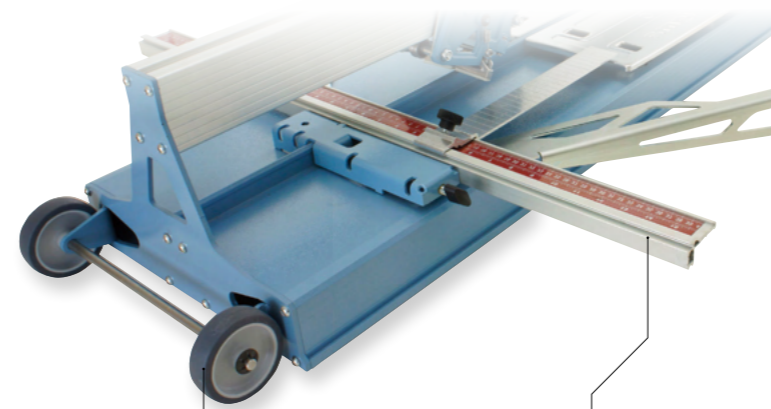

Completa di ruote per il trasporto
Complete with wheels for easy transport

Misura anteriore liberamente posizionabile
Freely positionable front measure

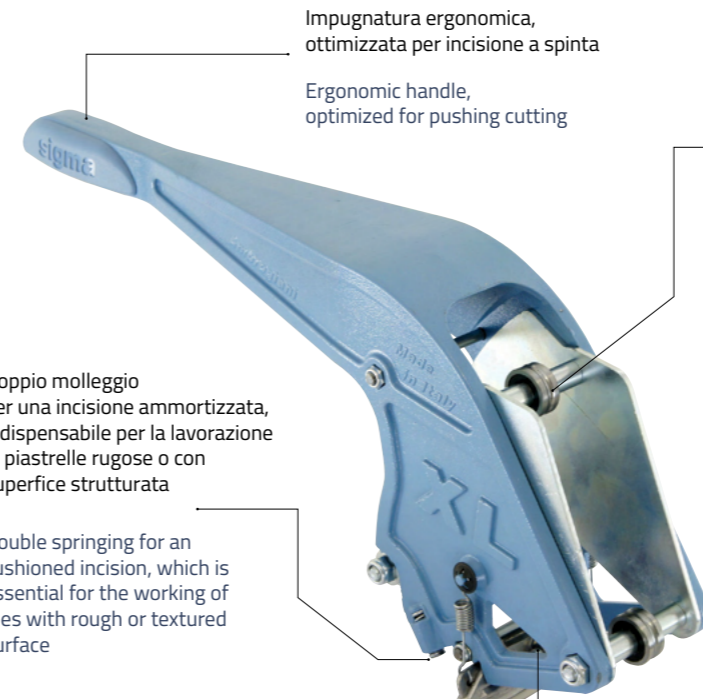

Impugnatura ergonomica, ottimizzata per incisione a spinta
Ergonomic handle, optimized for pushing cutting

Doppio molleggio per una incisione ammortizzata, indispensabile per la lavorazione di piastrelle rugose o con superficie strutturata

Double springing for an cushioned incision, which is essential for the working of tiles with rough or textured surface

Piede di spacco molto largo, 100mm, ottimale per il taglio facile di grandi piastrelle
Foot gap very wide, 100mm, perfect for easy cutting large tiles

Piede di spacco in lega di alluminio, leggero ma rigido, per uno spacco efficace
Gap foot of aluminum alloy, light but rigid, for a effective split

Protezione antisegno intercambiabile
Protection to prevent marks interchangeable

Art.	Descrizione	Description		Euro
12D1	TAGLIAPIASTRELLE cm.205 completa di 90E3	TILE CUTTER cm.205 complete with art. 90E3	1	1420,00
12E1	TAGLIAPIASTRELLE cm.245 completa di 90E3	TILE CUTTER cm.245 complete with art. 90E3	1	1590,00
Ricambi		Spare parts		
14X	Rotella per incisione Ø 13 mm f.4 s.4 completa.	Ø 13 mm complete scoring wheel , h.4 t.4	20	9,10
104058	Protezione sottopiede antisegno per leva 12/CDE	No-mark protection for 12/CDE handle	1	1,70
90LG	Barra metrica orientabile per Art. 12/CDE 55-0-55cm.	Swivel measurement bar for Art.12/CDE 55-0-55cm.	1	84,00

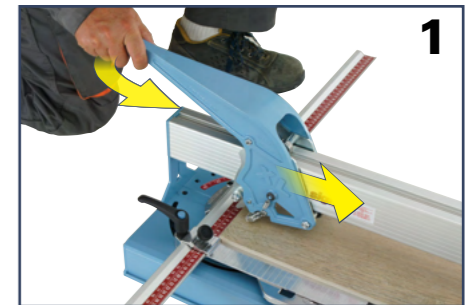

L'impugnatura scorre sulla guida inox, appoggiandosi su tre cuscinetti con 6 corone di sfere, per una incisione perfettamente rettilinea nel tempo.

The handle slides on the steel rails, laying on 3 bearings with 6 ball rings, for a perfectly straight incision over the time.

La rotella è dotata di sistema di recupero del gioco laterale

The wheel is equipped with a recovery system of side clearance

Incisione a trazione, pratica e veloce
Pulling incision, fast and practical



Art. 7F cm.37

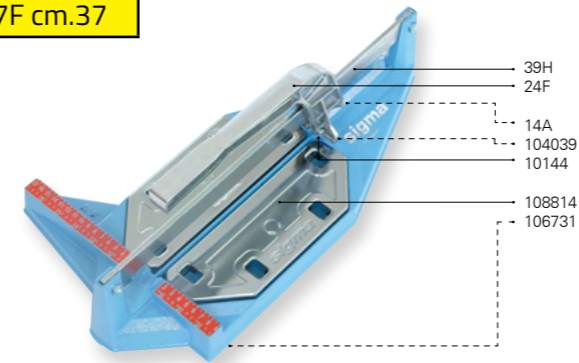

Art. 2G cm.37

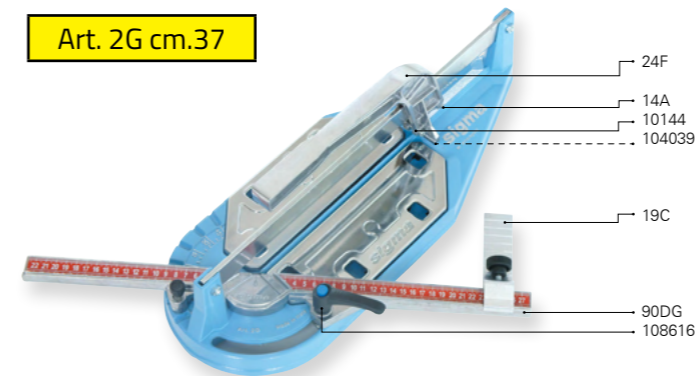

Art. 3L cm.55

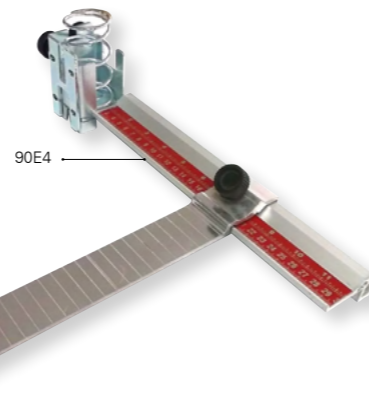
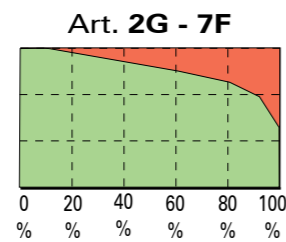
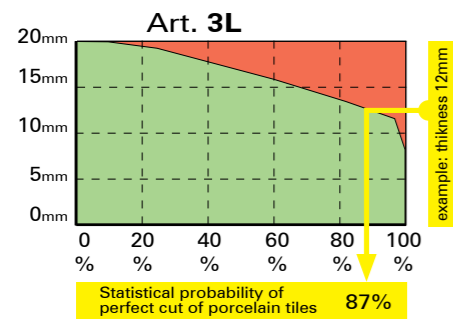
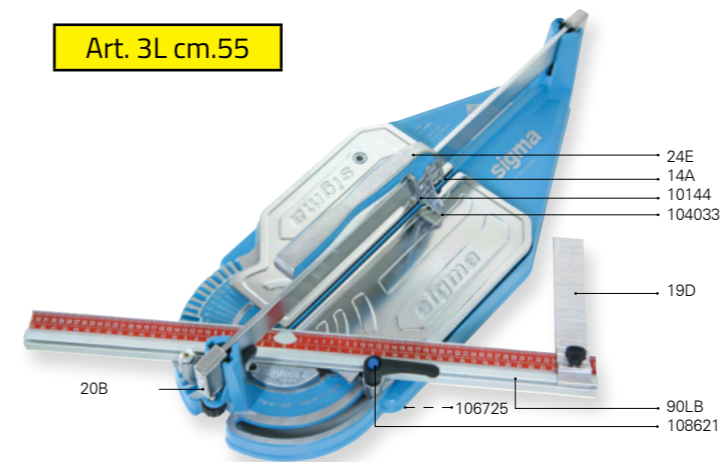

International patents

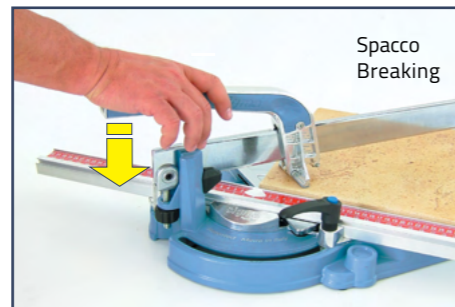
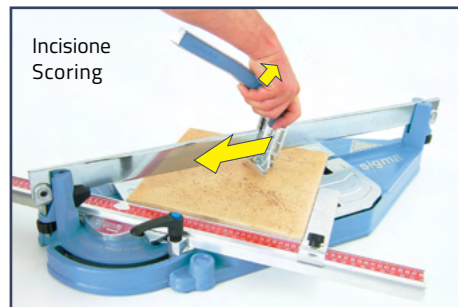

Art.	Descrizione	Description		Euro
7F	TAGLIA PIASTRELLE cm.37	TILE CUTTER cm.37	6	85,00
2G	TAGLIA PIASTRELLE cm.37	TILE CUTTER cm.37	6	125,00
3L	TAGLIA PIASTRELLE cm.55	TILE CUTTER cm.55	2	248,00
Optionals		Optionals		
14T	Rotella incisione TITANIO, Ø mm 12, completa, per Art. 7F-2G-2B3	Ø 12 mm TITANIUM scoring wheel, for Art. 7F-2G-2B3	20	8,00
90E4	Battuta con misura anteriore per Serie 3	Front stop with measure for Serie 3	1	84,00
Ricambi		Spare parts		
14A	Rotella per incisione Ø 12 mm completa, per Art.7F-2G-2B3	Ø 12 mm scoring wheel, complete, for Art. 7F-2G-2B3	20	5,10
24F	Impugnatura a trazione scavo 6, per Art.2G-7F	Pulling handle 6 mm groove, for Art. 2G-7F	1	27,70
24E	Impugnatura ERGONOMICA a trazione scavo 8, con protezioni antisegno, completa di Art.14A per Art. 3L*-3B*	ERGONOMIC pulling handle 8 mm groove, with Art.14A, NO-MARK protection, for Art. 3L*-3B*	1	40,40
104039	Protezione sottopiede antisegno per leva Art. 24F.	NO-MARK protection for pulling handle Art.24F.	10	1,00
104033	Protezione sottopiede antisegno per leva Art. 24E-24K.	NO-MARK protection for pulling handle Art. 24E-24K.	10	1,50
104031	Protezione sottopiede antisegno per Art. 2D4	NO-MARK protection for Art. 2D4	10	1,50
10144	Cuscinetto a sfere rinforzato 16/5/5 per leva Art. 24E-24F	Reinforced ball bearing 16/5/5 for Art. 24E-24F	1	3,40
90DG	Barra metrica per Art.2G	Measurement bar for Art.2G	1	30,00
90LB	Barra orientabile per Art. 3L*-3B* 47-0-35cm.	Swivel measurement bar for Art.3L-3B 47-0-35cm	1	67,00
107126	Righetta metrica adesiva per Art. 3/L. 3/B	Adhesive measurement tape for Art. 3/L. 3/B	1	5,70
19C	Squadretta Art. 2G	Square for Art. 2G	1	8,50
19D	Squadretta per Art. 3	Square for Art. 3	1	12,50
108616	Pomolo M8x25 per Art. 2G.	Knob M8x25 for Art. 2G.	1	4,20
108621	Pomolo a leva M8x40 per Art. 3L-3B4.	Clamping knob lever M8x40 for Art. 3L-3B4.	1	5,10
106731	Tappo 13/17 H16 per Art.2G-7F	Foot 13/17 H16 for Art. 2G-7F	6	0,57
106725	Tappo piede 20/25 H24 per Art. 3L*-3B*	Rubber foot 20/25 H24 for Art. 3L*-3B*	6	1,10
20B	Bilico scavo 15 completo per art.3L	Complete adjustable support screw 15 for art. 3L	1	9,20

Art.									
7F	37 cm 14,6 inc	26 cm 10,2 inc	3-15 mm 9/16inc	600 Kg.	2,3 Kg.	6 pz. 15,3 kg.	55 x 47 x 36 cm.	120 pz.	
2G	37 cm 14,6 inc	26 cm 10,2 inc	3-15mm 9/16inc	600 Kg.	2,6 Kg.	6 pz. 17,1 Kg.	55 x 47 x 36 cm.	120 pz.	
3L	55 cm 21,7 inc	38 cm 15,0 inc	0-19mm 3/4 inc	1050 Kg.	7,9 Kg.	2 pz. 17,2 Kg.	78 x 42 x 30 cm.	36 pz.	

Incisione a trazione o a spinta
Pulling or pushing incision

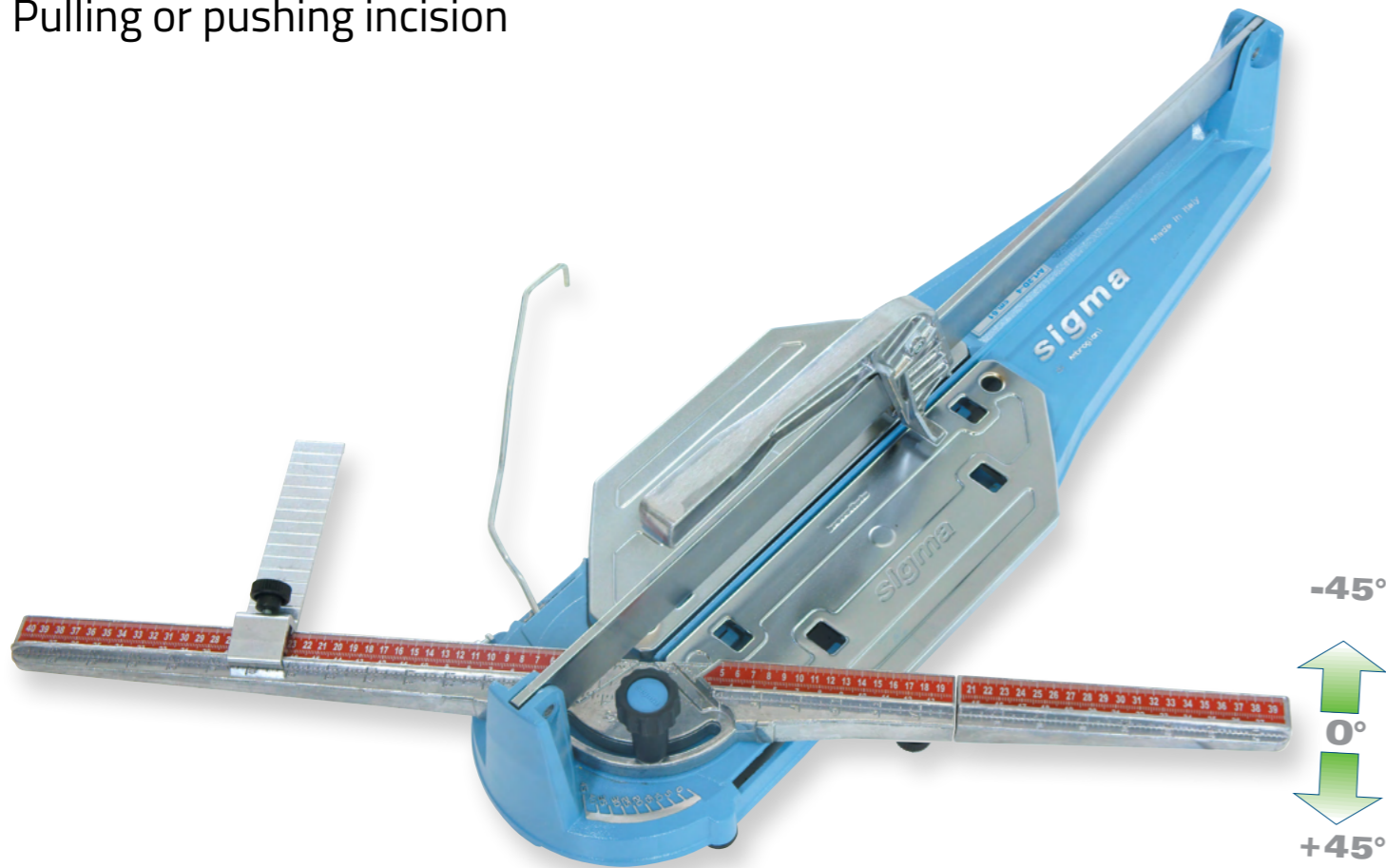

Art. 2B3 cm.66

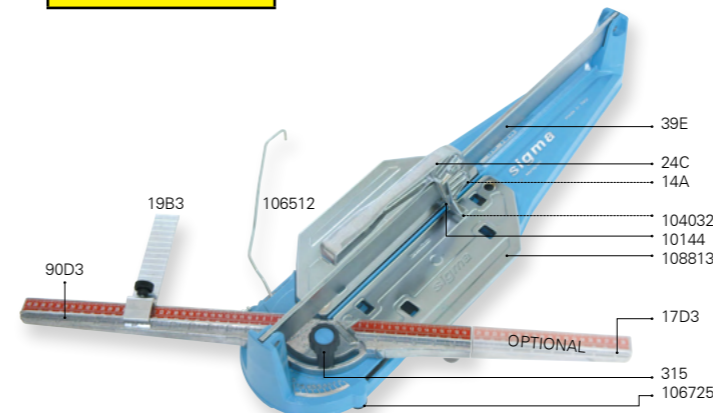

Art. 2D4 cm.61

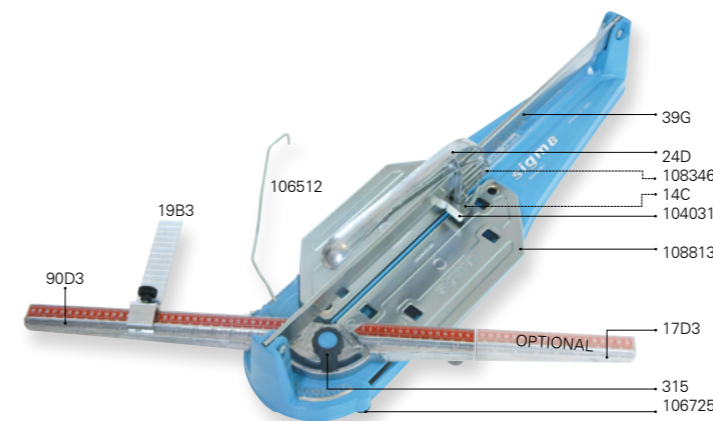

Art.	Descrizione	Description		Euro
	Incisione veloce a trazione	Fast pulling incision		
2B3	TAGLIA PIASTRELLE cm.66	TILE CUTTER cm.66	3	235,00
	Incisione forte a spinta	Strong pushing incision		
2D4	TAGLIA PIASTRELLE cm.61	TILE CUTTER cm.61	3	241,00
	Optionals	Optionals		
17D3	Prolunga metrica 21-40 cm. per Art. 2B3-2D4	Calibrated extension 21-40 cm. for Art. 2B3-2D4	1	15,00
14T	Rotella incisione TITANIO, Ø mm 12, completa, per Art. 2B3	Ø 12 mm TITANIUM scoring wheel, for Art. 2B3	20	8,00
	Ricambi	Spare parts		
14A	Rotella per incisione Ø 12 mm completa, per Art. 2B3	Ø 12 mm scoring wheel, complete, for Art. 2B3	20	5,10
14C	Rotella per incisione Ø 15 mm completa, per Art. 2D4	Ø 15 mm scoring wheel, complete, for Art. 2D4	20	6,60
24C	Impugnatura a trazione scavo 7, per Art. 2B3	pulling handle 7 mm groove, for Art. 2B3.	1	35,80
24D	Impugnatura a spinta scavo 7, per Art. 2D4	Pushing handle, 7 mm groove, for Art. 2D4	1	47,30
104032	Protezione sottopiede antisegno per Art. 2B3	NO-MARK protection for Art. 2B3	1	1,50
104031	Protezione sottopiede antisegno per Art. 2D4	NO-MARK protection for Art. 2D4	1	1,50
10144	Cuscinetto a sfere 5/16/5 per Art. 2B3	Ball bearing 5/16/5 for Art. 2B3	1	3,40
108346	Cuscinetto 12/5/6,5 per Art. 2D4	Bearing 12/5/6,5 for Art.2D4	1	3,00
90D3	Barra metrica per Art. 2B3-2D4	Measurement bar for Art.2B3-2D4	1	37,00
107112	Righetta metrica 402 0 197 per Art.90D3	Measurement tape 402 0 197 for Art.90D3	1	4,60
19B3	Squadretta Art. 2B3-2D4	Square for Art. 2B3-2D4	1	10,20
315	Pomolo Ø40 M10x35 per Art. 2B3-2D4	Knob Ø40 M10x35 for Art. 2B3-2D4	1	5,10
106725	Tappo 20/25 H24 per Art. 2B3-2D4	Foot 20/25 H24 for Art. 2B3-2D4	6	1,10
108813	Piatto per Art. 2B3-2D4	Plate for Art. 2B3-2D4	2	10,40
Vendita a confezioni intere		Sold in full packs only		

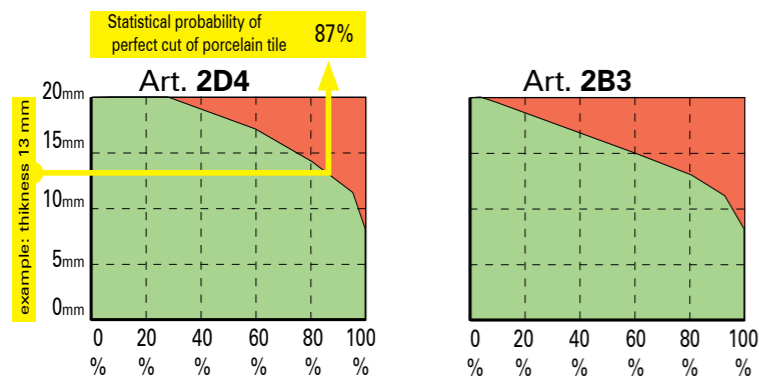

International patents

Art.								
2B3	66 cm 26,0 inc	46 cm 18,3 inc	3-19 mm 3/4 inc	800 Kg	7,0 Kg	3 pz. 24,0 Kg.	93 x 42 x 32 cm.	54 pz.
2D4	61 cm 24,0 inc	43 cm 17,0 inc	6-19 mm 3/4 inc	800 Kg	7,0 Kg	3 pz. 24,0 Kg.	93 x 42 x 32 cm.	54 pz.

2D4 Incisione a spinta
2D4 Pushing incision system



2B3 Incisione a trazione
2B3 Pulling incision system



Spacco
Breaking



**SERIE 3
PULLING INCISION**

3B4	3C2	3D4	Art.	Ricambi	Spare parts		Euro
●	●	●	24E	Impugnatura a trazione scavo 8	Pulling handle 8 mm groove	1	40,40
●	●	●	24AE	Impugnatura a trazione scavo 10	Pulling handle 10 mm groove	1	40,40
●	●	●	14A	Rotella per incisione Ø 12	Ø 12 mm scoring wheel	20	5,10
●	●	●	14T	Rotella per incisione Ø 12	Ø 12 mm scoring wheel	20	8,00
●	●	●	104033	Protezione sottopiede	NO-MARK protection	5	1,50
●	●	●	10144	Cuscinetto a sfere 16/5/5	Ball bearing 16/5/5	1	3,40
●			90LB	Barra orientabile 47-0-35	Swivel measurement bar	1	67,00
●	●	●	90LD	Barra orientabile 64-0-46	Swivel measurement bar	1	77,00
●	●	●	107126	Righetta metrica adesiva	Measurement tape	1	5,70
●	●	●	1079104	Dado M8 Esagono 20	Nut M8 Hex 20	1	1,70
●	●	●	19D	Squadretta	Square	1	12,50
●	●	●	108621	Pomolo a leva M 8x40	Clamping knob M 8x40	1	5,10
●	●	●	20B	Bilico completo	Compl. support screw	2	9,20
●	●	●	106725	Tappo piede Ø 20	Rubber foot Ø 20	8	1,10
●	●	●	90E4	Battuta con misura anteriore	Front stop with measure	1	87,00

SERIE 3 MAX

3B4M	3C3M	3D4M	3E4M	3F4M	Art.	Ricambi	Spare parts		Euro
●					24M08X	Impugnatura MAX scavo 8	MAX handle 8 mm groove	1	66,00
●	●	●			24M10X	Impugnatura MAX scavo 10	MAX handle 10 mm groove	1	66,00
			●		24M15X	Impugnatura MAX scavo 15	MAX handle 15 mm groove	1	66,00
				●	24M20X	Impugnatura MAX scavo 20	MAX handle 20 mm groove	1	66,00
●	●	●	●	●	14MX	Rotella per incisione Ø 19	Ø 19 mm scoring wheel	20	15,00
●	●	●	●	●	104058	Protezione sottopiede	NO-MARK protection	5	1,70
●	●	●	●	●	10166	Cuscinetto a sfere 16/5/5	Ball bearing 16/5/5	1	3,40
●					90LB	Barra orientabile 47-0-35	Swivel measurement bar	1	67,00
●	●	●			90LD	Barra orientabile 64-0-46	Swivel measurement bar	1	77,00
●			●	●	90LE	Barra orientabile 64-0-64	Swivel measurement bar	1	84,00
●	●	●	●	●	107126	Righetta metrica adesiva	Measurement tape	1	5,70
●	●	●	●	●	1079104	Dado M8 Esagono 20	Nut M8 Hex 20	1	1,70
●	●	●	●	●	19D	Squadretta	Square	1	12,50
●	●	●	●	●	108621	Pomolo a leva M 8x40	Clamping knob M 8x40	1	5,10
●	●	●	●	●	20B	Bilico completo	Compl. support screw	2	9,20
●	●	●	●	●	106725	Tappo piede Ø 20	Rubber foot Ø 20	8	1,10
●	●	●	●	●	90E4	Battuta con misura anteriore	Front stop with measure	1	87,00

**SERIE STANDARD
SERIE DIAGONALE**

6	5A	5B	4A	Art.	Ricambi	Spare parts		Euro
●	●	●		24E	Impugnatura scavo 8 mm	Handle 8 mm groove	1	40,40
			●	24AE	Impugnatura scavo 10 mm	Handle 10 mm groove	1	40,40
●	●	●	●	14A	Rotella per incisione Ø 12	Ø 12 mm scoring wheel	20	5,10
●	●	●	●	104033	Protezione sottopiede	Protection for Pulling handle	5	1,50
●	●	●	●	10144	Cuscinetto a sfere 16/5/5	Ball bearing 16/5/5	1	3,40
●				90	Barra orientabile 4A-5B-5A	Swivel measurement bar	1	52,00
●				17	Prolunga 21-34 orientabile	Swivel measure 21-34	1	16,10
●	●	●	●	19A	Squadretta	Square	1	15,00
●				19	Squadretta orientabile 60°	60° Swivel square	1	19,00
●	●	●	●	91	Righetta metrica adesiva	Measurement tape	1	4,60
●	●	●	●	92	Pomolo Ø60 M10x25	Clamping knob Ø60 M10x25	1	4,60
●	●	●	●	20	Bilico scavo 8 completo	Compl. support screw 8pp	2	9,20
●			●	20A	Bilico scavo 10 completo	Compl. support screw 10	2	9,20
●				10673	Tappo piede Ø 14	Rubber foot Ø 14	10	0,34
●	●	●	●	10675	Tappo piede Ø 15	Rubber foot Ø 15	10	0,46

SERIE 3 KLICK KLOCK

3LK	3BK	3CK	3DK	3EK	Art.	Ricambi	Spare parts		Euro
●	●				24K	Impugnatura KK scavo 8mm	Handle 8mm groove	1	52,00
●	●	●	●	●	14C	Rotella per incisione Ø 15	Ø 15 mm scoring wheel	20	6,60
●	●	●	●	●	104033	Protezione sottopiede	NO-MARK protection	5	1,50
●	●	●	●	●	10144	Cuscinetto a sfere 16/5/5	Ball bearing 16/5/5	1	3,40
●	●				90LB	Barra orientabile 47-0-35	Swivel measurement bar	1	67,00
		●	●		90LD	Barra orientabile 64-0-46	Swivel measurement bar	1	77,00
●	●	●	●	●	90LE	Barra orientabile 64-0-64	Swivel measurement bar	1	84,00
●	●	●	●	●	107126	Righetta metrica adesiva	Measurement tape	1	5,70
●	●	●	●	●	1079104	Dado M8 Esagono 20	Nut M8 Hex 20	1	1,70
●	●	●	●	●	19D	Squadretta	Square	1	12,50
●	●	●	●	●	108621	Pomolo a leva M 8x40	Clamping knob M 8x40	1	5,10
●	●	●	●	●	20B	Bilico completo	Compl. support screw	2	9,20
●	●	●	●	●	106725	Tappo piede Ø 20	Rubber foot Ø 20	8	1,10
●	●	●	●	●	90E4	Battuta con misura anteriore	Front stop with measure	1	87,00
●	●	●	●	●	104064	Supporto Sx completo	Complete Left support	1	10,30
●	●	●	●	●	104065	Supporto Dx completo	Complete Right support	1	10,30
					ALTERNATIVA	ALTERNATIVE			
●	●				24M08X	Impugnatura MAX scavo 8	MAX handle 8 mm groove	1	66,00
					24M10X	Impugnatura MAX scavo 10	MAX handle 10 mm groove	1	66,00
		●			24M15X	Impugnatura MAX scavo 15	MAX handle 15 mm groove	1	66,00

Sistema di taglio estensibile per piastrelle di grande formato
Extensible Large format tile cutting system

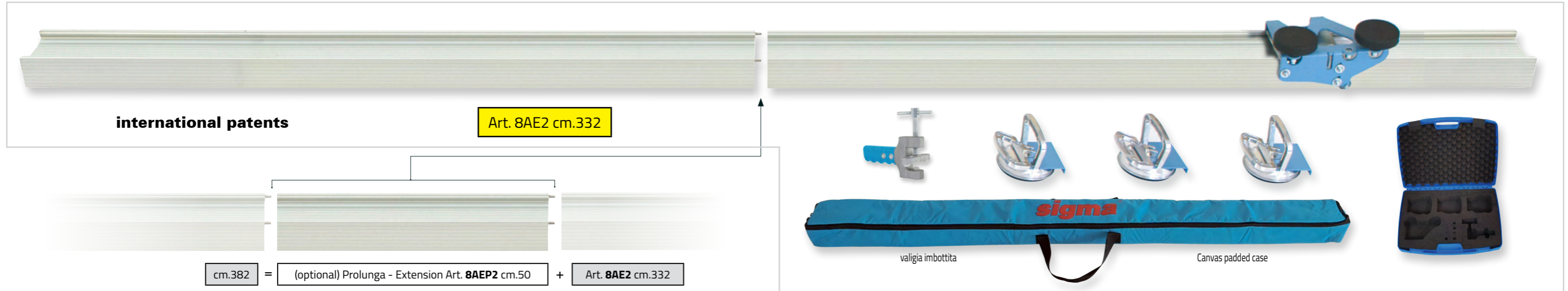

KERA-CUT EXT: attrezzatura di taglio per piastrelle di grande formato. La guida in alluminio, fissata sulla piastrella tramite ventose antimacchia, permette lo scorrimento del carrello con rotellina di incisione. Successivamente la separazione si effettua con il separatore in dotazione. Con questo sistema si possono tagliare anche piastrelle di spessore superiore a 7mm (solo di gres porcellanato morbido). Per il trasporto le guide e tutti gli accessori sono contenuti nelle due valigie in dotazione.

In alternativa, per tagliare materiali spessi e particolarmente duri, un carrello porta smerigliatrice consente un taglio segato con disco diamantato (vedi pag. 31).

KERA-CUT EXT: cutting equipment for large format tiles; the divisible aluminum guide, fixed on the tile by stain-free suction cups, allows at the carriage to slide with an scoring wheel. By this system, tiles with thickness higher 7 mm (only soft porcelain gres).

For transport, the guides and all the accessories are contained in the two suitcases supplied.

As an alternative, for cutting thick and particularly hard materials a angle-grinder holder carriage is available which allows sawing with a diamond blade (see page 31).



Carrello di scorrimento su piste indurite, con ruote rivestite in materiale plastico antiusura e doppi cuscini a sfere.

Sliding carriage on hardened tracks, with wheels coated wear-resistant plastic material and double ball bearings.

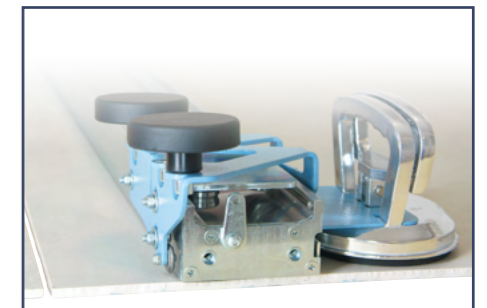

Fissaggio sulla piastrella con ventose antimacchia, liberamente posizionabili, adatte anche a superfici ruvide.

Fixing on the tile with anti-stain suction cups, freely positioned, also suitable for rough surfaces.

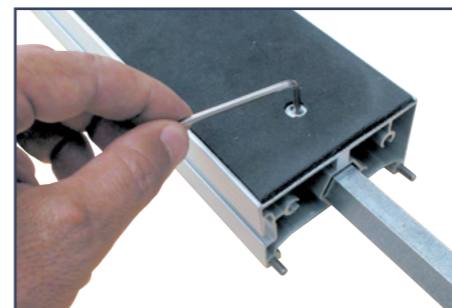

Le guide nella parte inferiore sono ricoperte da gomma antiscivolo e antimacchia.

Giunzione delle guide a 3 punti in acciaio ad alta precisione.

The guide in the lower part are covered with non-slip and stain-free rubber. High precision 3 points connection between the guides



Il giunto di collegamento in acciaio esagonale da 19 mm di spessore e 480 mm di lunghezza, garantisce grande rigidità e rettilinearità dei profili estrusi assemblati

The 19 mm thick and 480 mm long hexagonal steel connection joint guarantees high rigidity and straightness of the assembled extruded profiles.

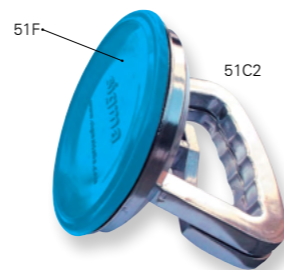

La spinta con leva a due mani permette una incisione molto profonda.

The push with two-handed lever allows a very deep incision.

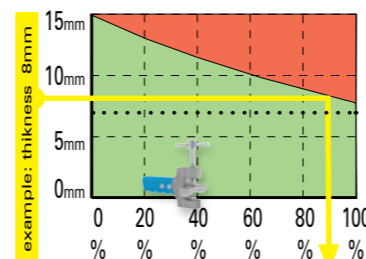

Statistical probability of perfect cut of porcelain tile 90%

Art.							
8AE2	332 cm 130,7 inc	234 cm 92,4 inc	0 ⇔ 7 mm 1/4 inc	0 - 7 mm Thick 100% 😊	14,2 Kg	2 pz. 17,5 Kg.	185 x 19 x 19 cm. + 52 x 43 x 16 cm.
				8 - 12 mm Thick 50% 😞			
8AE2+8AEP2	382 cm 150,4 inc	270 cm 106,3 inc	0 ⇔ 7 mm 1/4 inc	0 - 7 mm Thick 100% 😊	18,2 Kg	3 pz. 21,5 Kg.	185x19x19 + 54x22x15 + 52 x 43 x 16 cm.
				8 - 12 mm Thick 50% 😞			

KERA-CUT EXT



Optionals e ricambi:
Optionals and spare parts:

Art. 8AEP2 cm.50



Art. 41D



Art. 41D Per la separazione di piastrelle con alto spessore
Art. 41D For the separation of tiles with high thickness



Art. 38F5



Art. 38F5 Fissaggio al piano con supporti girevoli, per tagli ripetitivi; ruotando, la guida si solleva fino a 21mm, per rimuovere rapidamente la piastrella.
Art. 38F5 Fixing to the working table with swivel supports, for repetitive cuts; by turning, the guide raises up to 21mm and allows a quickly tile removing.

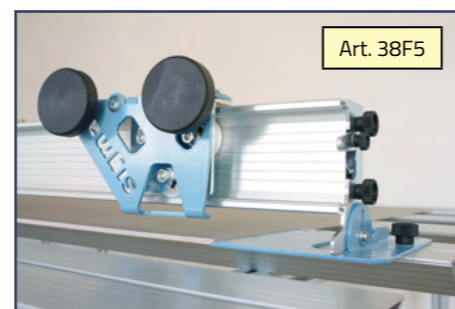
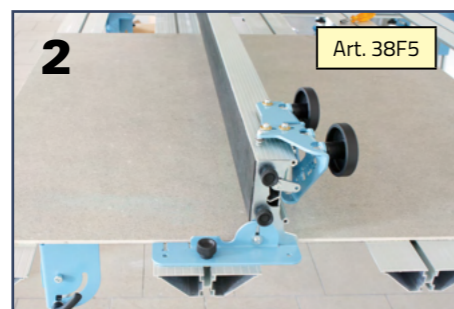
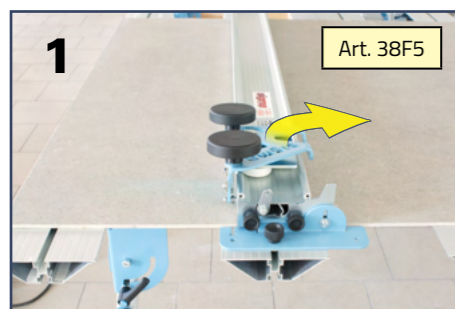

Art.	Descrizione	Description		Euro
8AE2	SISTEMA DI TAGLIO estensibile KERA-CUT EXT cm. 332	TILE CUTTING SYSTEM extensible KERA-CUT EXT cm.332	1	590,00
Optionals		Optionals		
8AEP2	Prolunga per 8AE cm.50	Extension for 8AE cm.50	1	78,00
38F5	Coppia supporti girevoli	Couple rotating supports	1	37,50
SEPARATORE universale per piastrelle preincise		Universal SEPARATOR for pre-scored tiles		
41D	O>20mm	O>20mm	1	44,00
Ricambi versione EXT		EXT version Spare parts		
51C2	Ventosa alluminio per KERA-CUT Ø120 (40Kg.)	KERA-CUT aluminum suction cup Ø120 (40Kg.)	1	32,00
14G	Rotella di incisione Ø13mm, di serie per 8AE2 8C2 8D2 8E2 8G2 8CE 8DE	Ø13 mm. scoring wheel, standard for 8AE2 8B2 8C2 8D2 8E2 8G2 8CE 8DE	20	7,70
51F	Gomma per ventosa 51C2 Ø120	Rubber plate for suction cup 51C2 Ø120	1	14,70
43K	Valigia in tela imbottita per guide KERA-CUT 171 cm	Canvas padded case for KERA-CUT guides 171 cm	1	36,00
38F6	Carrello EXT completo	EXT complete cart	1	93,00
41E	O>15 mm	O>15mm	1	19,90
Ricambi vecchie versioni		Old version Spare parts		
14K	Rotella d'incisione 19mm, di serie per: 8C 8E.	Ø19 mm. scoring wheel standard for: 8C 8E.	1	16,70

KERA-FLEX EXT



Il Kera-Flex, montato sulla guida kera-cut permette il taglio segato, con disco diamantato fino spessori di 25 mm. Facile regolazione del fermo di profondità.

The Kera-Flex, mounted on the kera-cut guide, allows cutting with a diamond blade up to 25 mm thick. Easy adjustment of the depth stop

Art.	Descrizione	Description		Euro
38F11D	KERA-FLEX EXT con disco 75B predisposto per smerigliatrice standard, attacco filetto M14	KERA-FLEX EXT with disc 75B ready for standard angle grinder, spindle thread M14	1	214,00
38F11PD	KERA-FLEX EXT con disco 75B predisposto per smerigliatrice attacco filetto 5/8-11 UNC per U.S.A. Canada	KERA-FLEX EXT with disc 75B ready for angle grinder, spindle thread 5/8-11 UNC, for U.S.A. Canada	1	217,00
Optionals		Optionals		
87E4	Waterkit sistema di raffreddamento per l'utensile diamantato con nebulizzazione d'acqua (10 lt), garantisce maggior velocità e finitura. Compatibile anche per versioni precedenti. Necessario l'utilizzo di smerigliatrice a batteria.	Waterkit cooling system for the diamond tool with water spray (10 liters), guarantees better speed and finish. Also compatible for previous versions. The use of a cordless grinder is necessary.	1	89,00
458	Fissaggio extra per Waterkit 87E4	Extra fixing for Waterkit 87E4	1	13,80
75B	Disco diamantato Ø 115mm foro 22,2, spes.1,3 mm per materiali da 5 a 20 mm	Diamond disc Ø 115 mm hole 22,2 mm, thick 1,3 mm, tile 5 to 20 mm	1	19,00
75D	Disco diamantato Ø 125mm foro 22,2 mm, spes.1,4 mm per materiali da 5 a 25 mm	Diamond disc Ø 125 mm hole 22,2 mm, thick 1,4 mm, tile 5 to 25 mm	1	23,00
75C3	Disco diamantato Ø 115mm foro 22,2 mm, spes.1,1 mm per materiali da 3 a 12 mm	Diamond disc Ø 115 mm hole 22,2 mm, thick 1,1 mm, tile 3 to 12 mm	1	40,50



Art.63E

Art.63F

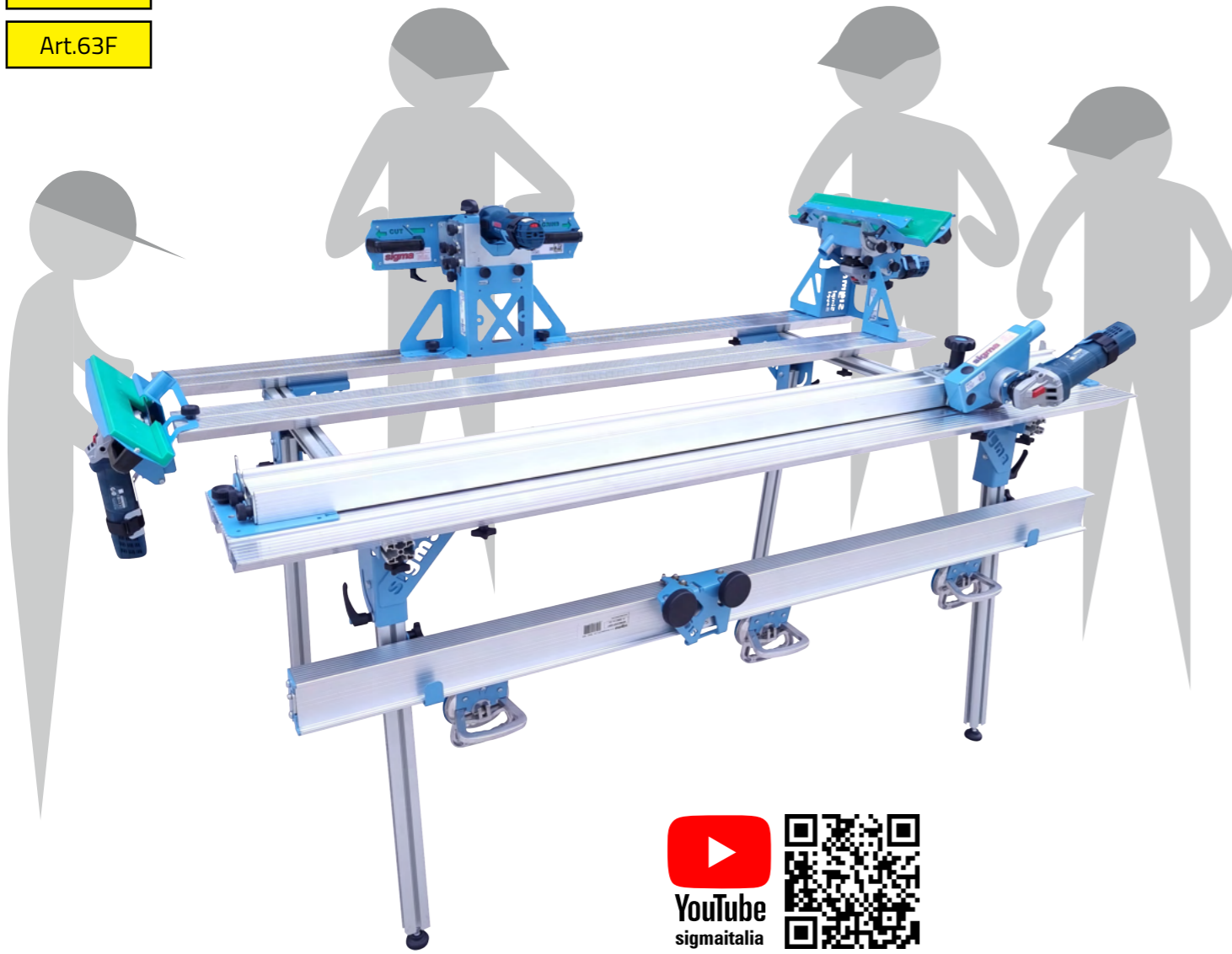

Con i suoi piani facilmente posizionabili è possibile creare zone vuote, per effettuare lavorazioni che attraversano la piastrella, come fori e tasche. E' inoltre possibile aggiungere o spostare i piani per creare una superficie di lavoro continua.

With its easily positioned aluminium planks you can create empty areas to allow workings that pass through the tile, such as holes and pockets. It is also possible to add or move planks to create a continuous worktop.



I Banchi da Lavoro sono collegabili fra loro per ottenere un piano di appoggio unico lungo 360cm.

Workbenches can be connected to each other get a single worktop 360cm long.

Banco da Lavoro smontabile e modulare, particolarmente adatto come appoggio per lavorare lastre e piastrelle ceramiche. Grazie alla sua struttura in alluminio, leggera e robusta, garantisce un' ottimo sostegno per le piastrelle di grande formato. Al banco da Lavoro è possibile fissare facilmente svariate attrezzature, come la guida di taglio Kera-Cut, kit fissaggio a banco per Simple Bevel e Jolly Edge, ecc.. Sono disponibili accessori come: morsetti (art. 400) per serraggio, ganci (art. 402) per sostenere la guida di taglio Kera-Cut, distanziali (art.409) di rialzo piastrella per effettuare tagli trasversali con un disco diamantato, ecc...

Demountable and modular **Workbench**, particularly suitable as a support for working slabs and ceramic tiles. Thanks to its aluminium structure, light and sturdy, it guarantees an excellent support for large format tiles. At the Workbench you can easily attach various equipment, such as Kera-Cut cutting guide, table fixing kit for Simple Bevel and Jolly Edge, etc.. Accessories such as: clamps for tile (item 400), hooks for support the Kera-Cut cutting guide (item 402), tile riser spacers to make transversal cuts with a diamond blade (art.409) etc ...



Per un facile trasporto, è sufficiente piegare le gambe, minimizzando l'ingombro, oppure è possibile smontare completamente il banco in pochi minuti riducendo l'ingombro in una scatola di cartone.

For easy transport, it is sufficient to bend the legs, minimize the overall dimensions, or the workbench can be completely dismantled in a few minutes reducing the space in a carton box.



Art.									
63E	180 cm 70,8 inc	96 cm 37,8 inc	82 cm 32 inc	200 Kg.	22 Kg.	1 pz. 24 Kg.	187 X 48 X 24 cm		10 pz.
63F	180 cm 70,8 inc	151,5 cm 59,6 inc	82 cm 32 inc	200 Kg.	29 Kg.	1 pz. 31 Kg.	187 X 48 X 24 cm		10 pz.

Art. 63EP - 4 PZ (for Art 63E)

Art. 63FP - 6 PZ (for Art 63F)

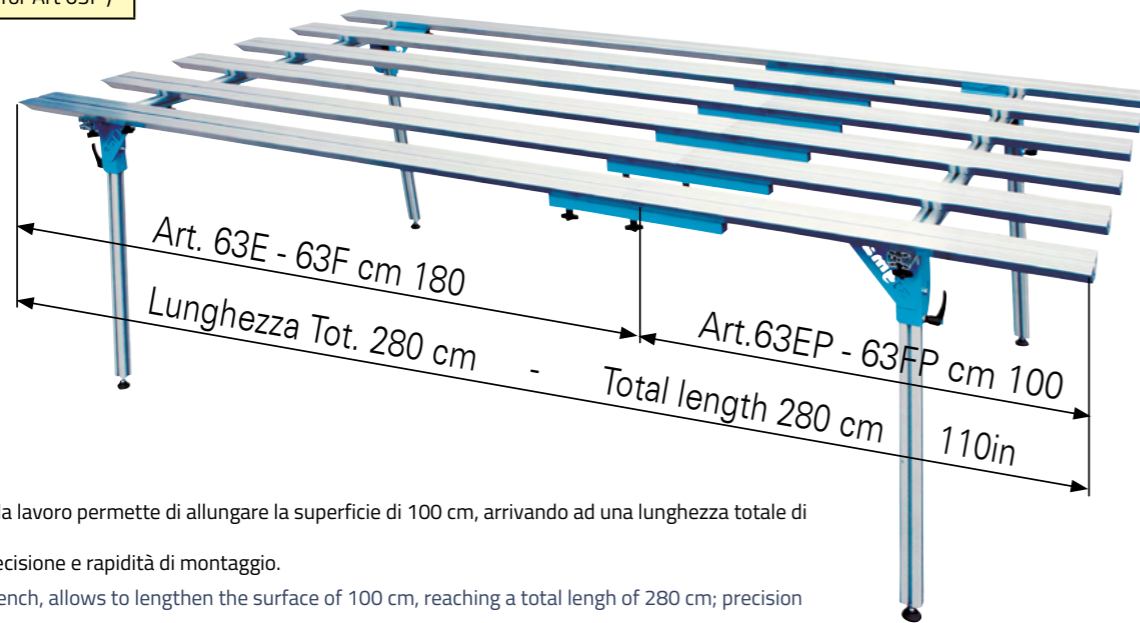

Prolunga per banco da lavoro permette di allungare la superficie di 100 cm, arrivando ad una lunghezza totale di 280 cm; accoppiamento di precisione e rapidità di montaggio.

Extension for Workbench, allows to lengthen the surface of 100 cm, reaching a total length of 280 cm; precision and quick assembly.

Art. 409



I Distanziali alzano la piastrella permettendo il taglio con disco trasversale della stessa, senza danneggiare il Banco da lavoro. Non vanno utilizzati per il taglio ad incisione (50 pz per box).

The Spacers raise the tile allowing cutting with the disk transverse it without damaging the workbench. Do not use for scoring cutting (50 pz for any box).

Art. 400



Morsetti per il Banco da lavoro sono indispensabili per fermare correttamente la piastrella o lastra durante l'esecuzione di lavorazioni.

The clamps for the workbench are indispensable to fix the tile correctly during processing.



Art. 63FP - 6 PZ (for Art 63F)

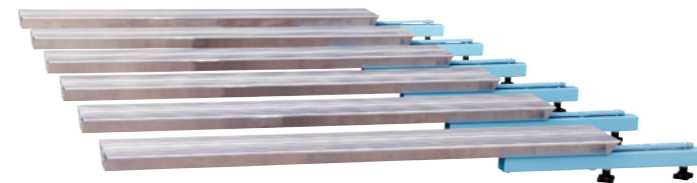

Art. 63EP - 4 PZ (for Art 63E)

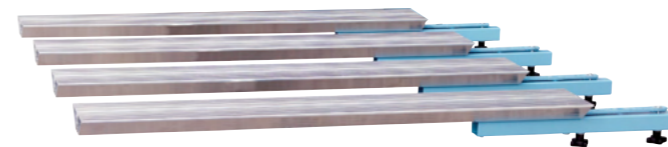

Art. 402



I Ganci per il Banco da lavoro sostengono e proteggono la guida di taglio Kera-Cut da urti accidentali. The hooks for the workbench support and protect the Kera-Cut cutting guide from accidental impacts.



Art.	Descrizione	Description		Euro
63E	Banco di Lavoro 180x96 in alluminio, completo di 4 pianetti e staffa per unire 2 banchi	Alluminium Workbench 180x96 complete with 4 alluminium planks and bracket to join 2 benches	1	580,00
63F	Banco di Lavoro 180x151 in alluminio, completo di 6 pianetti e staffa per unire 2 banchi	Alluminium Workbench 180x151 complete with 6 alluminium planks and bracket to join 2 benches	1	730,00
Optionals		Optionals		
63EP	Prolunga da 100 cm per Banco da lavoro 63E (4 barre)	Extension 100 cm for Workbench 63E (4 bars)	1	265,00
63FP	Prolunga da 100 cm per Banco da lavoro 63F (6 barre)	Extension 100 cm for Workbench 63F (6 bars)	1	380,00
400	Kit 2 Morsetti	Kit of 2 clamps	1	33,50
402	Kit 2 Ganci per sostegno guida di taglio Kera Cut	Kit of 2 hooks for support the Kera Cut cutting guide	1	21,00
409	Kit 50 distanziali per piano	Kit of 50 spacers for raise the worktop	1	21,00
103853	Pianetto aggiuntivo 180x13 cm.	Additional alluminium planks 180x13 cm.	1	82,00
439	Ulteriore staffa per unire 2 banchi di lavoro	Bracket to join 2 Workbenches	1	8,50

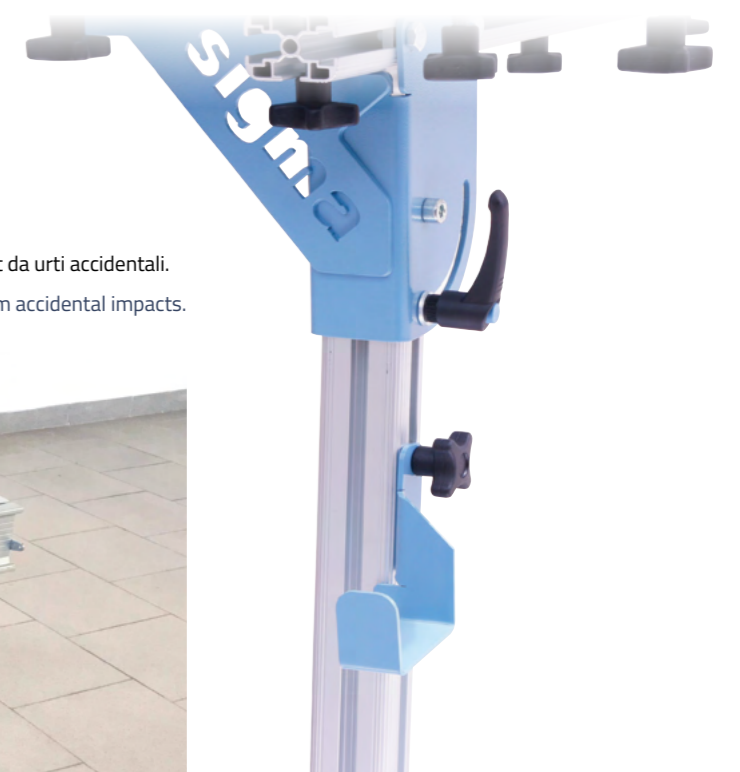

KERA-LIFT per la movimentazione e la posa di grandi formati For handling and laying of large format tiles

“KERA-LIFT” attrezzatura con ventose per il sollevamento, la movimentazione e la posa di grandi piastrelle, liberamente adattabile alla forma della piastrella senza l'uso di utensili, è composta da guide scorrevoli fra loro per adattarsi a qualsiasi forma della lastra, equipaggiata con ventose Pro-Grip. La nuova ventosa ad azionamento rapido perfetta anche per materiali strutturati, dotata di vuotometro e gomma antimacchia facilmente sostituibile. Le ventose possono scorrere lungo il profilo per adattarsi a qualsiasi esigenza. Tutti i modelli sono certificati CE.

“KERA-LIFT” equipment with suction cups for lifting, handling and laying large tiles, freely adaptable to the shape of the tile without the use of tools, is composed of guides that slide together to adapt to any shape of the slab, equipped with Pro-Grip suction cups. The new fast-acting suction cup is also perfect for structured materials, equipped with a vacuum gauge and easily replaceable stain-resistant rubber. The suction cups can slide along the profile to adapt to any need. All models are CE certified.

KERA-LIFT Art. 1A6
max: 340 x 160 cm

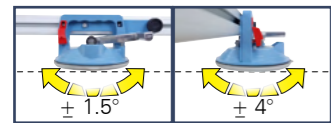

Ventose Basculanti
Tilting suction cups

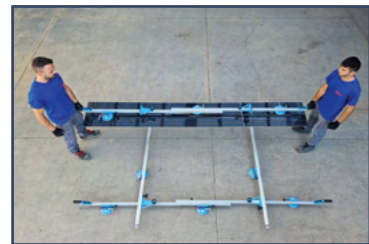
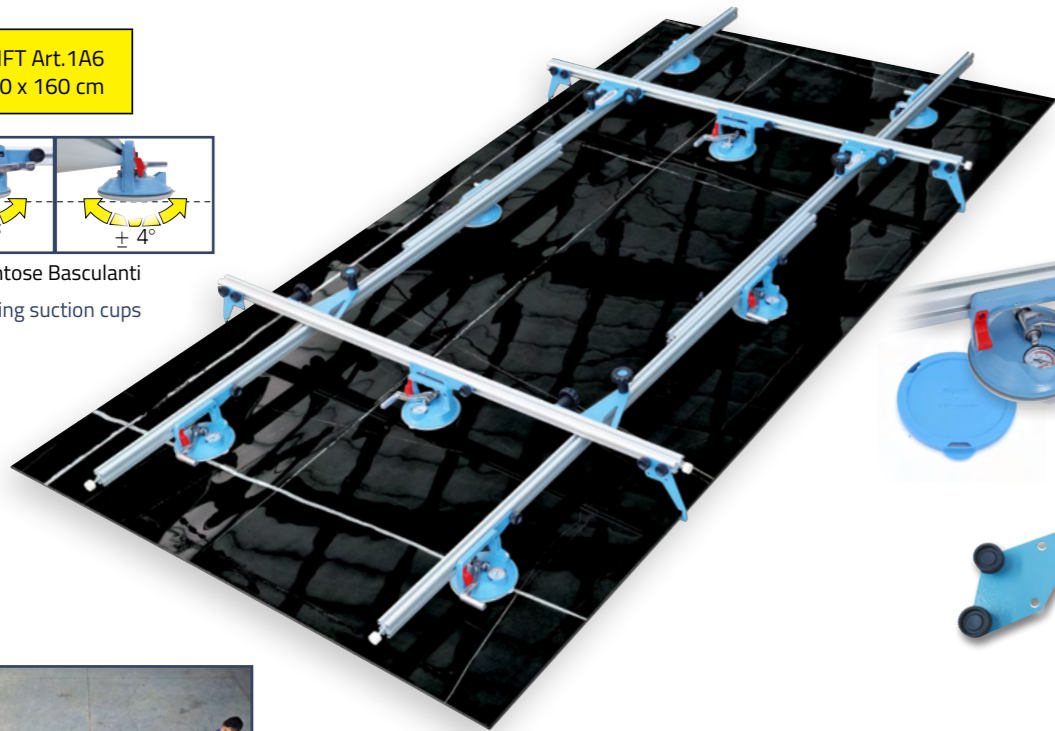

Traversi smontabili per lastre strette
Dismantable cross bar for narrow slabs

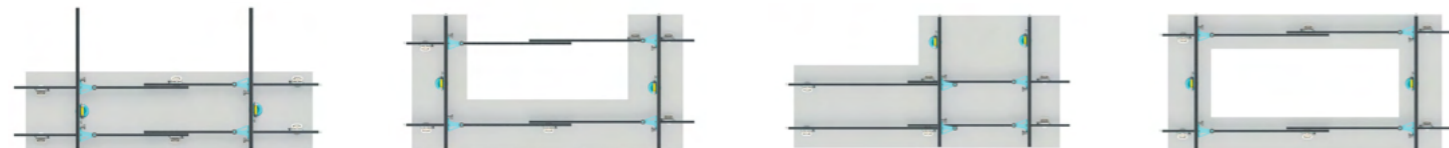

International patents

Art.							
1A6	340 cm max - 195 cm min 134 inc max - 76 inc min	160 cm max - 40 cm min 63 inc max - 16 inc min	150 Kg. Max.	CE	22,5 Kg.	1 pz. 24,0 Kg	205 x 43 x 36 cm
1D3	340 cm max - 195 cm min 134 inc max - 76 inc min	80 cm max - 20 cm min 31 inc max - 8 inc min	75 Kg. Max.	CE	8,0 Kg.	1 pz. 9,0 Kg	203 x 28 x 20 cm



Keralift completo di:
Keralift complete with:

x 8 pz

Nuova ventose a leva
Pro-Grip Ø160 con
Vuotometro e protezione

New Pro-Grip Suction
cups Ø160 with Vacuum
indicator and protection

x 4 pz

Sicure Anticaduta
Safety fall brackets

NEW

KERA-LIFT Art. 1D3
max: 340 x 100 cm

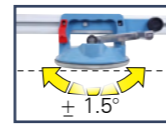

Ventose Basculanti
Tilting suction cups



NEW

Ventosa “PRO-GRIP” Ø 160 mm - 120 Kg Forza “PRO-GRIP” Suction Cup Ø 160 mm - Force 120 Kg

Brevetti Internazionali - International patents

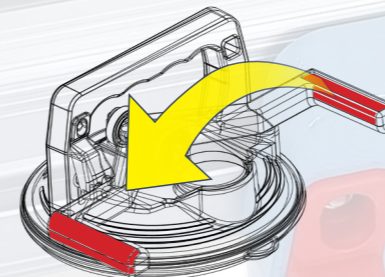

ATTIVAZIONE IN
1 SECONDO
ACTIVATION IN
1 SECOND

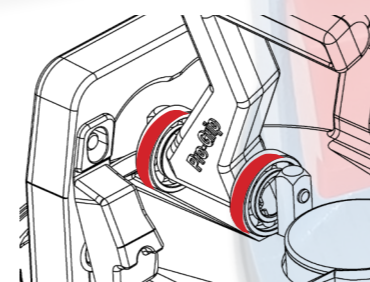

ATTIVAZIONE
SENZA SFORZO
EFFORTLESS
ACTIVATION

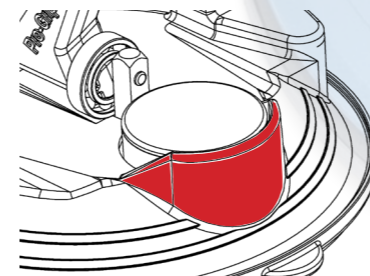

VUOTOMETRO
PROTETTO
PROTECTED
VACUUM GAUGE

GOMMA
SOSTITUIBILE
REPLACEABLE
RUBBER PAD

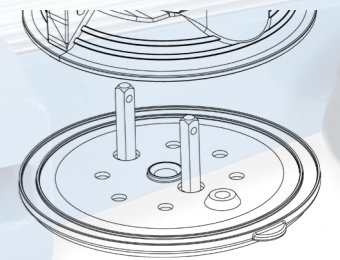

VUOTOMETRO
SOSTITUIBILE
REPLACEABLE
VACUUM GAUGE

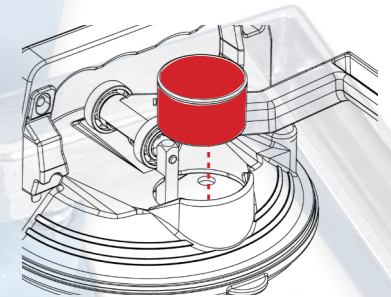

ADATTA ANCHE PER
MATERIALI RUVIDI
ALSO SUITABLE FOR
ROUGH MATERIALS

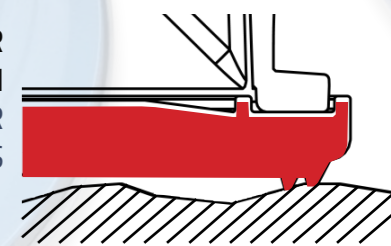

NO MANUTENZIONE
MAINTENANCE FREE





Art. 421

(Kit Carrello non compatibile con le versioni precedenti del Kera-Lift)
(Carriage Kit is not compatible with the old version of Kera-Lift)

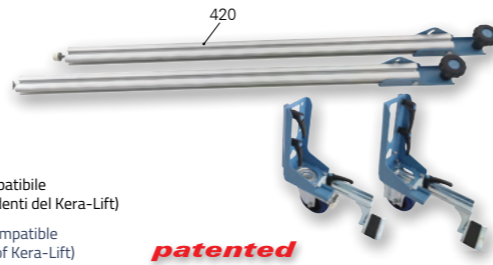

Il Kit Carrello Art. 421 permette la movimentazione del telaio in maniera facile e sicura. Grazie alla ruota girevole è possibile l'esecuzione di percorsi con curve. I cavalletti permettono il perfetto sostegno della lastra anche in fase di stesura della colla. Sono presenti due sicure Anti-caduta rivestite in gomma.

The Carriage Kit Art. 421 allows the movement of the frame in a easy and safe way. Thanks to the rotating wheel it is possible to run routes with curves. The easels allow the perfect support of the slab even during the application of the glue. There are two safe Anti-fall brackets coated in rubber.



Durante il trasporto, la Persona "A" può direzionare il telaio a piacimento.

During transport, the person "A" can direct the frame in any direction.

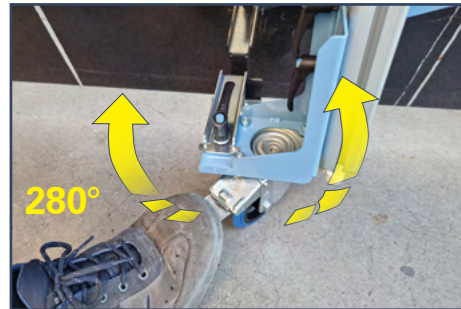

Ruota Anti-segno girevole di 280° permette la movimentazione con curve del telaio, bloccabile in posizione rettilinea.

Non-marking wheel, which swivels at 280°; lockable in straight position.

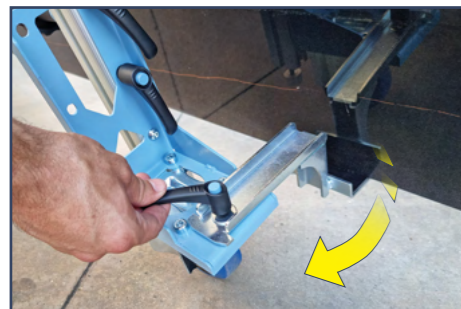

Le sicure Anti-caduta rivestite in gomma, sono rimovibili per le operazioni di posa.

Anti-fall safety devices, rubber coated, can be removed for laying operations.

Art. 424

(Kit Maniglie 100% compatibile con le versioni precedenti del Kera-Lift)
(Handles Kit is 100% compatible with the old version of Kera-Lift)



Le Maniglie rendono ancora più comodo il sollevamento della lastra, possono essere posizionate a piacimento.

Handles make lifting the slab more comfortable, and can be positioned as desired.

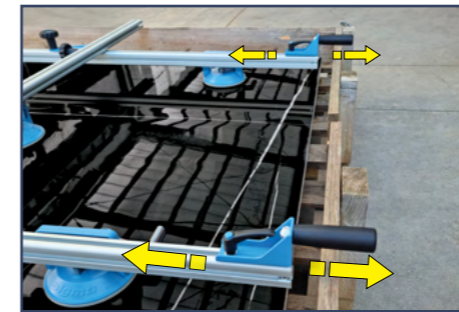

Art.	Descrizione	Description	Euro
1A6	Sollevatore KERA-LIFT 340x160 cm. Completo con 8 ventose Pro-Grip e sicure anticaduta	Lift KERA-LIFT 340x160 cm. Complete with 8 Pro-Grip suction cups and safety fall protection	1050,00
1D3	Sollevatore KERA-LIFT 340 cm. Completo con 3 ventose Pro-Grip e sicure anticaduta	Lift KERA-LIFT 340 cm. Complete with 3 Pro-Grip suction cups and safety fall protection	398,00
421	KIT CARRELLO completo di 2 ruote con supporto lastra+ 2 piedi apribili	CARRIAGE KIT Complete with: 2 wheels with slab support +2 opening feet	297,00
424	KIT MANIGLIE completo di 4 pz	HANDLES KIT complete with 4 pz	109,00
Ricambi modelli correnti		Current spare parts	
51M3	Ventosa Pro-Grip Ø160 mm per longheroni KERA-LIFT 1A6-1D3	Pro-Grip Ø160 suction cup mm for straight bar of KERA-LIFT 1A6-1D3	106,00
51M4	Ventosa Pro-Grip Ø160 mm per traverse KERA-LIFT 1A6	Pro-Grip Ø160 suction cup mm for cross bar of KERA-LIFT 1A6	106,00
103822	Traverso 97 cm	97 cm cross bar	36,00
103824	Traverso 157 cm	157 cm cross bar	54,00
10026	Vuotometro per ventosa Pro-Grip	Vacuum gauge for Pro-Grip suction cup	8,50
51M1	Gomma per ventosa Pro-Grip Ø160 mm con protezione	Rubber for Pro-Grip Ø160 mm suction cup with protection	43,00
105111	Protezione per la gomma delle ventose Pro-Grip Ø160 mm	Protection for the rubber of the Pro-Grip 160 mm suction cups	4,00
Ricambi vecchi modelli 2019-2023 1A4-1A5-1D2		Old models 2013-2018 Spare parts 1A4-1A5-1D2	
51D2	Ventosa a leva Ø120 mm per montaggio su longherone art 1A4	Lever Suction Cup Ø120 mm for mounting on long bar 1A4	40,00
51P3	Ventosa a pompa con vuotometro per KERA-LIFT 1A5 Ø150 mm. Portata max 90kg (45kg a norme CE)	Pump Suction Cup Ø150 mm with vacuum gauge for KERA-LIFT 1A5 Capacity max 90kg (45 kg to CE rules)	199,00
10518	Protezione per la gomma delle ventose Ø150 mm	Protection for the rubber of Ø150 mm suction cups	5,40
51F	Gomma per ventosa 51D2 Ø120 mm	Rubber for 51D2 Suction Cup Ø120 mm	14,70
Ricambi vecchi modelli 2013-2018 1A-1B-1C-1D-1A2-1B2-1A3-1B3		Old models 2013-2018 Spare parts 1A-1B-1C-1D-1A2-1B2-1A3-1B3	
51D	Ventosa a leva Ø120 mm per montaggio su longherone	Lever Suction Cup Ø120 mm for mounting on long bar	43,50
51E	Ventosa a leva Ø120 mm per montaggio su traverso alto	Lever Suction Cup Ø120 mm for mounting on upper cross bar	44,00

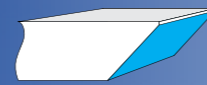

Art. 37B2D

Art. 37B2PD



"J-Pro" Scivolando in appoggio sul bordo della piastrella / lastra (gres, marmo, granito, ecc.), garantisce l'**uniformità del taglio su tutta la lunghezza dello spigolo lavorato**, copiando esattamente le curve fisiologiche della lastra; cosa che non sarebbe possibile con una macchina guidata da una guida rigida.

Può lavorare, in una **unica passata**, piastrelle con spessore 5<20mm e dimensione da minimo 30 cm a infinito. **Permette il taglio inclinato a 46°.**

Semplice e rapida la regolazione della distanza del disco dallo spigolo della piastrella.

Può lavorare a secco con la predisposizione di l'aspirazione delle polveri o ad umido con WaterKit.

Predisposto per smerigliatrici 700 - 1400 W, completo di disco art.75B, capacità disco max.125mm.

"J-Pro" Sliding resting on the edge of the tile / slab (stoneware, marble, granite, etc.), guarantees the **uniformity of the miter on the entire length of the edge worked**, exactly copying the physiological curves of the slab; something that would not be possible with a tool guided by a rigid guide.

It can work, in a **single pass**, tiles with a thickness of 5<20mm and a size from a minimum of 30cm to infinity.

Allows cutting at a 46° angle.

Simple and quick adjustment of the distance of the disc from the edge of the tile. It can work dry with the predisposition for dust extraction or wet with WaterKit.

Ready for 700 - 1400 W grinders, complete with disc art.75B, disc capacity max.125mm.

Predisposizione di l'aspirazione delle polveri.
Connection for dust extraction.

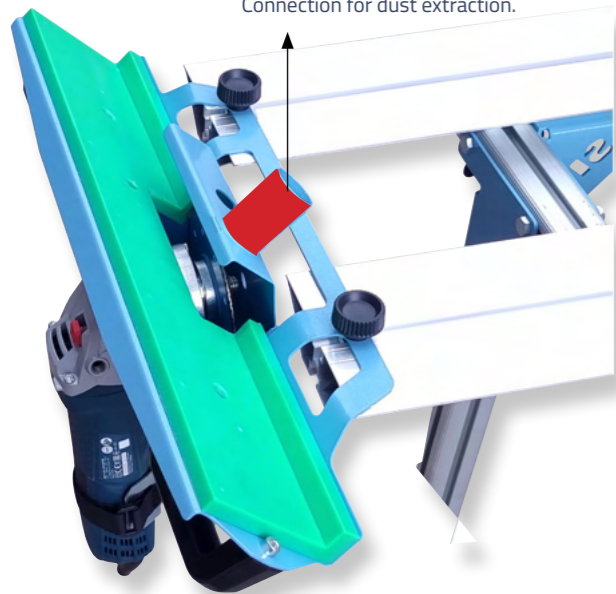

Art. 87E4



Waterkit sistema di raffreddamento per l'utensile diamantato con nebulizzazione d'acqua (10 lt), garantisce maggior velocità e finitura.

Waterkit cooling system for diamond tools, with water spray (10 liters), guarantees better speed and finish. Also compatible with previous versions.

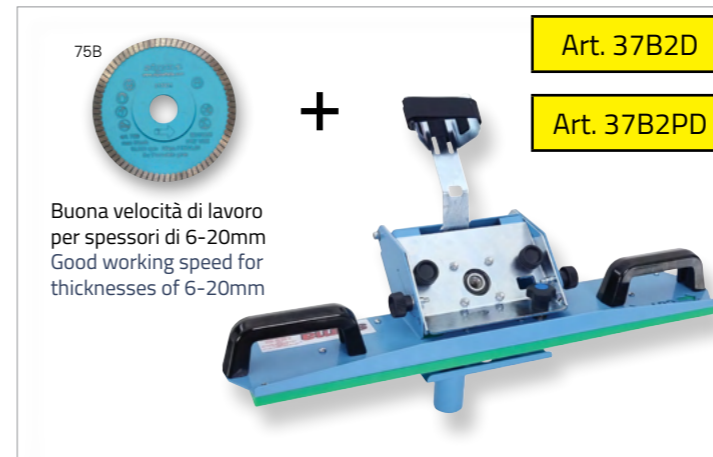

Dischi compatibili:
Compatible diamond discs:

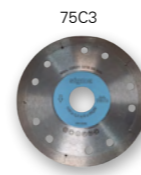

Elevata rifinitura, ideale per spessori 3-6 mm
High finishing, ideal for thicknesses of 3-6 mm



Alta velocità di lavoro e lunga durata, per spessori 6-20mm
High working speed and long life, for thicknesses of 6-20mm

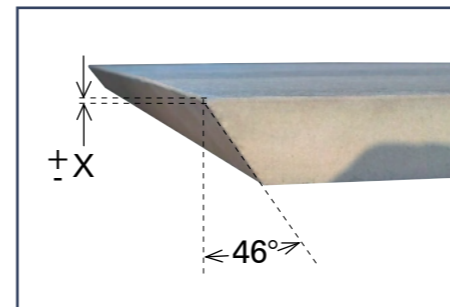

Art.	Descrizione	Description		Euro
37B2D	J-PRO con attacco universale M14, con disco 75B	J-PRO with universal spindle thread M14, with diamond disc 75B	1	260,00
37B2PD	J-PRO con attacco universale 5/8-11 UNC; per U.S.A.- Canada con disco 75B	J-PRO with universal spindle thread 5/8-11 UNC ; for U.S.A. - Canada with diamond disc 75B	1	262,00
87E4	Waterkit sistema di raffreddamento per l'utensile diamantato con nebulizzazione d'acqua (10 lt).	Waterkit cooling system for the diamond tool with water spray (10 liters).	1	89,00
458	Fissaggio extra per Waterkit 87E4	Extra fixing for Waterkit 87E4	1	13,80
	Disco diamantato Ø 115 foro 22,2 mm Specifiche pag. 46	Diamond disc Ø 115 mm hole 22,2 mm Specifications on page 46		
75B	Spessore 1,4 mm per materiali da 6 a 20 mm	Thick 1,4 mm for materials from 6 to 20 mm thick	10	19,00
75C3	Spessore 1,1 mm per materiali da 3 a 6 mm	Thick 1,1 mm for materials from 3 to 6 mm thick	10	40,50
75E	Spessore 1,7 mm per materiali da 6 a 20 mm	Thick 1,7 mm for materials from 6 to 20 mm thick	10	52,00
pag.45/49	Accessori per finitura	Accessoires for finishing		

Art.	Kg	BOX	BOX
37B2D - 37B2PD	3,8 Kg.	1 pz.	5,1 Kg. 57 x 39 x 25 cm.



Art. 37A3D

Art. 37A3PD



"JOLLY EDGE" Scivolando in appoggio sul bordo della piastrella / lastra (gres, marmo, granito, ecc.) , garantisce l'uniformità del taglio / smusso su tutta la lunghezza dello spigolo lavorato, copiando esattamente le curve fisiologiche della lastra; cosa che non sarebbe possibile con una fresa guidata da una guida rigida. Può lavorare, in una unica passata, piastrelle con spessore 5<20mm e dimensione da minimo 30 cm a infinito. Nella configurazione con disco diamantato, permette l'esecuzione di jolly a qualsiasi angolazione compresa fra 40° e 50°. Nella configurazione con mola diamantata, permette l'esecuzione di smussi rotondi (BULL) con raggio 6 - 8 - 10mm. Può lavorare a secco con la predisposizione di l'aspirazione delle polveri o ad umido con Water Kit. Predisposto per smerigliatrici 700 - 1400 W, completo di disco art.75B, capacità disco max.125mm.

"JOLLY EDGE" Sliding resting on the edge of the tile / slab (stoneware, marble, granite, etc.), ensures the uniformity of the miter along the entire length of the edge worked, copying exactly the physiological shapes of the slab; which would not be possible with a cutter guided by a rigid guide. It can work in a single pass, tiles with thickness 5 < 20mm and size from 30 cm to infinity. In the configuration with diamond blade, it allows the mitering at any angle from 40° to 50°. In the configuration with diamond grinding wheel, it allows the execution of Bullnose with radius 6 - 8 - 10mm. It can work dry with the predisposition for dust extraction or wet with Water Kit. The machine is ready for grinder 700 - 1400W. complete with blade disc art.75B, disc capacity max. 125mm

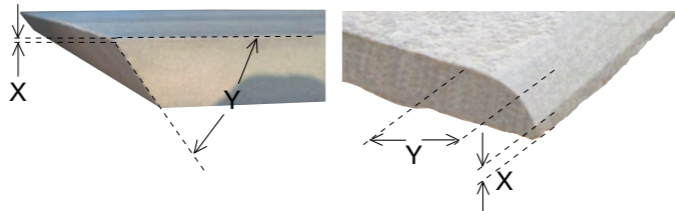

La macchina 37A3D-37A3PD con il kit 37C, va fissata ad un banco ed è consigliata per lavorare piastrelle strette e lunghe, come piastrelle per battiscopa, ecc.

The machine 37A3D-37A3PD with the kit 37C, to be fixed on a table, and recommended for long and narrow tile working, like skirting tiles.

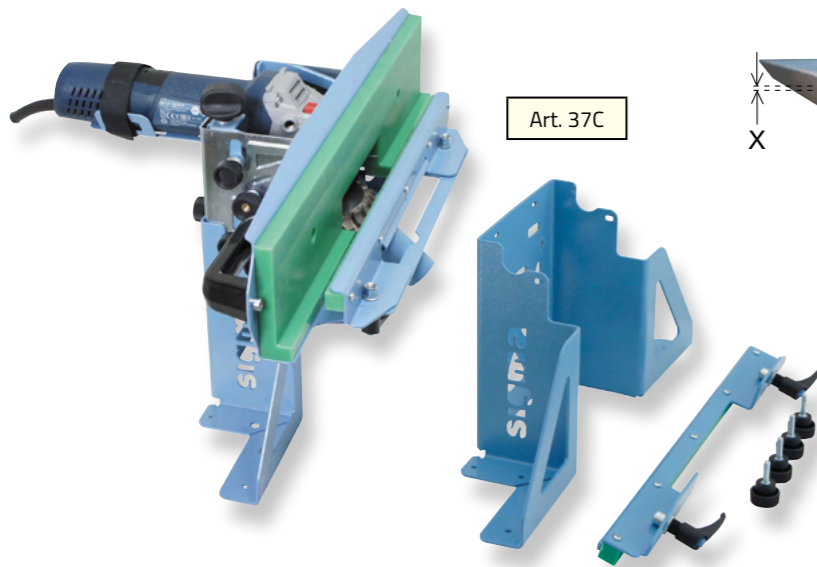

Art. 37C



Art. 87E4

Waterkit sistema di raffreddamento per l'utensile diamantato con nebulizzazione d'acqua (10 lt), garantisce maggior velocità e finitura. Compatibile anche per versioni precedenti.

Waterkit cooling system for the diamond tool with water spray (10 liters), guarantees better speed and finish. Also compatible for previous versions.

Art.				
37A3D - 37A3PD	4,5 Kg.	1 pz.	5,8 Kg.	57 x 39 x 25 cm.

Art. 37A3D

Art. 37A3PD

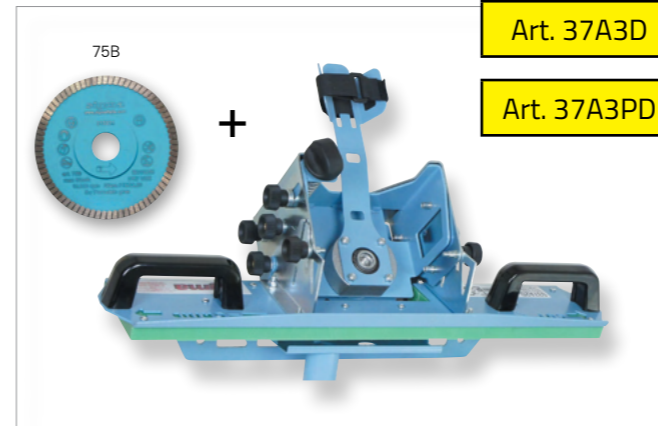

Dischi compatibili:
Compatible diamond discs:

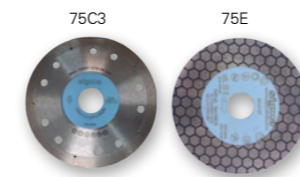

Mole compatibili per Toro:
Diamond grinding cups compatibles for Bull:

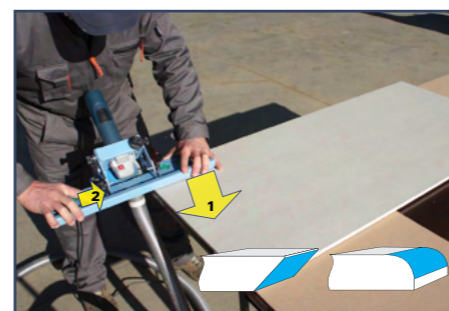
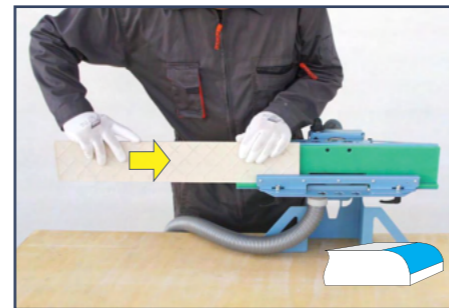

Mole per finitura manuale:
Diamond grinding pad for manual finishing:



Art.	Descrizione	Description		Euro
37A3D	JOLLY-EDGE con attacco universale M14, con disco 75B	JOLLY-EDGE with universal spindle thread M14, with diamond disc 75B	1	330,00
37A3PD	JOLLY-EDGE con attacco universale 5/8-11 UNC; per U.S.A.- Canada con disco 75B	JOLLY-EDGE with universal spindle thread 5/8-11 UNC ; for U.S.A.- Canada with diamond disc 75B	1	332,00
87E4	Waterkit sistema di raffreddamento per l'utensile diamantato con nebulizzazione d'acqua (10 lt).	Waterkit cooling system for the diamond tool with water spray (10 liters).	1	89,00
458	Fissaggio extra per Waterkit 87E4	Extra fixing for Waterkit 87E4	1	13,80
37C	Kit fissaggio al banco per smussatura battiscopa per Jolly-Edge	Table Fixing kit for edge skirting. For Jolly-Edge	1	76,00
	Disco diamantato Ø 115 foro 22,2 mm Specifiche pag. 46	Diamond disc Ø 115 mm hole 22,2 mm Specifications on page 46		
75B	Spessore 1,4 mm per materiali da 6 a 20 mm	Thick 1,4 mm for materials from 6 to 20 mm thick	10	19,00
75C3	Spessore 1,1 mm per materiali da 3 a 6 mm	Thick 1,1 mm for materials from 3 to 6 mm thick	10	40,50
75E	Spessore 1,7 mm per materiali da 6 a 20 mm	Thick 1,7 mm for materials from 6 to 20 mm thick	10	52,00
72L	Mola diamantata professionale Ø 115 raggio 8 ,6000 rpm durata 1000 mt. foro 22,2 mm Specifiche pag. 49	Professional diamond grinding cup d115 radius 8, 6000 rpm duration 1000 mt. hole 22.2 Specifications on page 49	1	329,00
72L10	Mola diamantata professionale Ø 115 raggio 10,6000 rpm durata 1000 mt. foro 22,2 mm Specifiche pag. 49	Professional diamond grinding cup d115 radius 10, 6000 rpm duration 1000 mt. hole 22.2 Specifications on page 49	1	329,00
	Mola diamantata Vacuum durata 300 mt. su gres porcellanato, foro 22,2 mm Specifiche pag. 49	Vacuum diamond grinding cup, duration 300mt (porcelain gres), hole 22,2 Specifications on page 49		
072V06S	Ø 115 raggio 6 , 6000 rpm	Ø115 radius 6, 6000 rpm	1	215,00
072V08S	Ø 115 raggio 8 , 6000 rpm	Ø115 radius 8, 6000 rpm	1	202,00
072V10S	Ø 115 raggio 10 , 6000 rpm	Ø115 radius 10, 6000 rpm	1	228,00
pag.45/49	Accessori per finitura Toro	Accessoires for Bullnose finishing		



Per la lavorazione di spigoli e bordi laterali For edges working

"SIMPLE BEVEL" Macchina per smussi di precisione su piastrelle e lastre in gres porcellanato, marmo, granito, vetro. Scivolando in appoggio sul bordo della piastrella, garantisce la uniformità dello smusso su tutta la lunghezza dello spigolo lavorato, copiando esattamente le curve fisiologiche della lastra; cosa che non sarebbe possibile con una fresa guidata da una guida rigida. Smusso da 0<12 mm (0<6 mm gres porcellanato). Regolabile a qualsiasi angolazione da 22° a 90°. Il TORO si ottiene con più passaggi ad angolazioni diverse. (r.6 nativo). Permette la rifinitura del bordo laterale della piastrella (max.30mm).

"SIMPLE BEVEL" Precision chamfer machine on gres porcelain tiles or Marble, Granite, Glass. Sliding resting on the edge of the tile, ensures the uniformity of the bevel along the entire length of the edge worked, following exactly the physiological curves of the slab; which would not be possible with a cutter guided by a rigid guide. Bevel from 0 to 12 mm (from 0 to 6mm on porcelain gres). Adjustable to any angle from 22° to 90°. The BULL is obtained with multiple passes at different angles. (r. 6 native). Allows finishing of the lateral edge of the tile (max.30mm)..

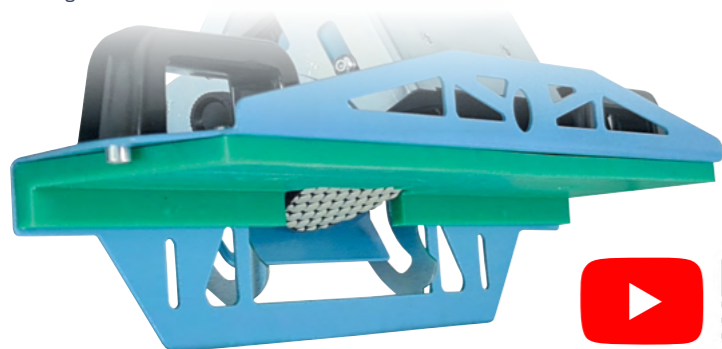

Art. 36C4

La macchina 36A5P con il kit 36C4, va fissata ad un banco ed è consigliata per lavorare piastrelle strette e lunghe, come piastrelle per battiscopa, strisce di piastrelle spessore 3-20mm, ecc. e dimensione da 30 cm a infinito.

The machine 36A5P with the kit 36C4, to be fixed on a table, and recommended for long and narrow tile working, like skirting tiles, strips of tile 3 to 20mm thick, etc.. and size from 30 cm to infinity.



Art. 87E4

Waterkit sistema di raffreddamento per l'utensile diamantato con nebulizzazione d'acqua (10 lt), garantisce maggior velocità e finitura. Compatibile anche per versioni precedenti.

Waterkit cooling system for the diamond tool with water spray (10 liters), guarantees better speed and finish. Also compatible for previous versions.

36A5D The machine is suitable for the following processes:



Finishing and polishing of lateral edge on tiles, cut with blade. 2 to 30mm thick tiles. Machining at 90°. Using grinding wheel art. 72E0200/-0800/-1500



Bevel, finishing and polishing of tiles edge, cut with blade. Angle 22°-90°. Back miter width 1-4mm, on gres porcelain material, Using grinding wheel art. 72E0050/-0200/-0800/1500



Finishing and polishing of tiles edge, previously chamfered with blade. Angle 22°-90°. Chamfer width: 1-18mm on gres porcelain material. Using grinding wheel art. 72E0200/-0800/-1500

Art. 36A5D



72D / 72DP + 72E0050



Mole compatibili:
Diamond grinding cups compatibles:

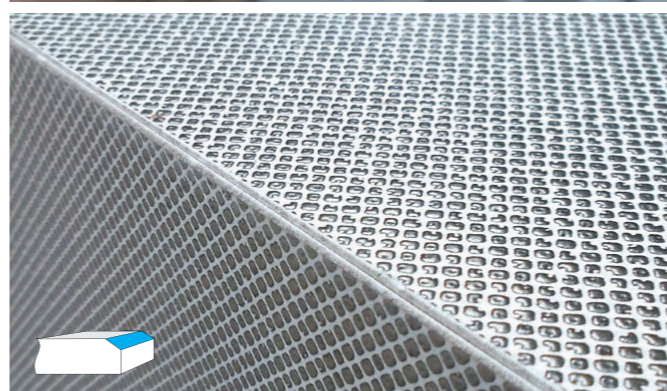
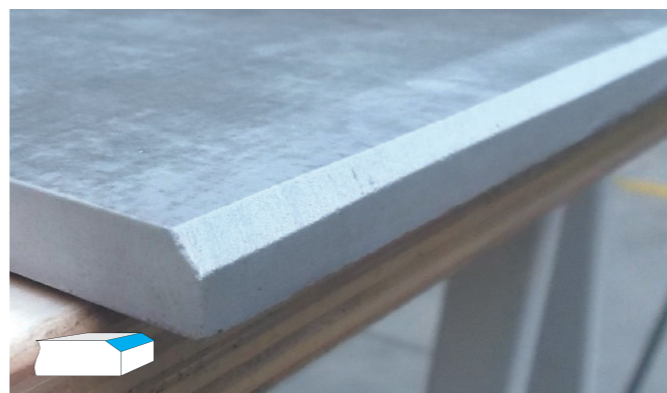
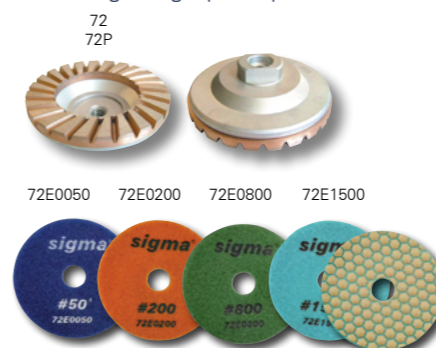

Art.	Descrizione	Description		Euro
	SIMPLE BEVEL predisposto per smerigliatrici 700 - 1400 W. Completo di art.72D + 72E capacità disco max.100mm	SIMPLE BEVEL ready for angle grinder 700 - 1400W. Complete with art.72D + 72E disk capacity max. 4"		
36A5D	Con attacco M14	With spindle thread M14	1	330,00
	Optionals	Optionals		
36C4	Kit fissaggio al banco per smussatura battiscopa per art. 36A4/A5	Table Fixing kit for bevel skirting. For art. 36A4/A5	1	102,00 Special Price 69,00
87E4	Waterkit sistema di raffreddamento per l'utensile diamantato con nebulizzazione d'acqua (10 lt).	Waterkit cooling system for the diamond tool with water spray (10 liters).	1	89,00
	Mola Diamantata Ø 100 a LUNGA DURATA Mole consigliate per smussi sopra i 4 mm. Velocità: 5000/11000 rpm.	LONG LIFE Diamond Grinding Wheels Ø 100 Recommended for chamfer above 4 mm. Speed: 5000/11000 rpm.		
72	Mola Ø Diamantata 100 attacco M14	Diamond Grinding Wheels Ø 100 thread M14	1	166,00
72P	Mola Diamantata Ø 100 attacco 5/8-11 UNC	Diamond Grinding Wheels Ø 100 spindle thread 5/8-11 UNC	1	169,00
	Mole consigliate per smussi sotto i 4 mm. Velocità: 3000/11000 rpm.	Recommended for chamfer below 4 mm. Speed: 3000/11000 rpm.		
72D	Platorello Ø100 mm Attacco M14 per traino mole con velcro	Pad Diam. 100 mm M14 thread for grinding wheel with velcro	1	10,00
	Mola diamantata Ø100 mm con velcro	Diamond Grinding wheel Ø100 mm - 4" with velcro		
72E0050	Grana 50 per sgrossatura	50-grit roughing	10	13,00
72E0200	Grana 200 per finitura	200-grit for finishing	10	13,00
72E0800	Grana 800 per semi-lucidatura	800-grit for semi-polishing	10	13,00
72E1500	Grana 1500 per lucidatura	1500-grit for polishing	10	13,00

Art.	Kg	Kg	BOX	BOX
36A5D - 36A5PD	4,5 Kg.	1 pz.	5,8 Kg.	57 x 39 x 25 cm.

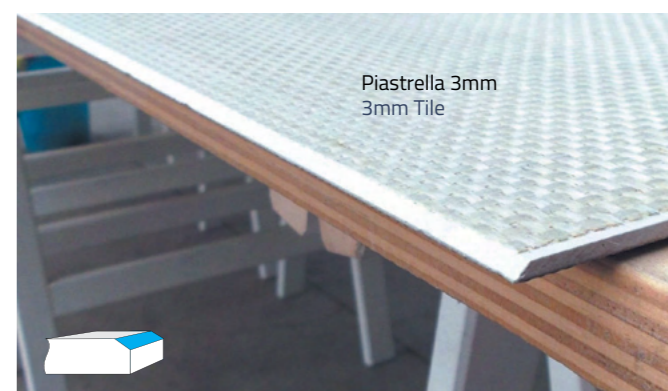

Piastrella 3mm
3mm Tile

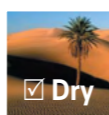
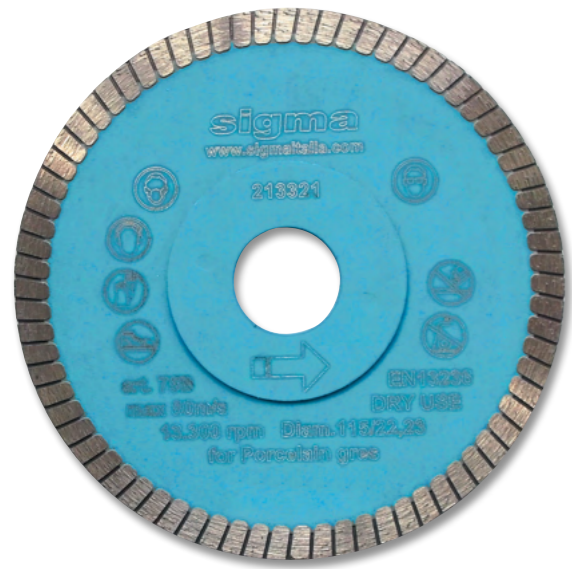

velocità - speed	[Progress bar]	
finitura - finish	[Progress bar]	
durata - life	350 linear mt *	
	spessore - thickness	resa - performance
gres porcellanato - porcelain	6 - 25 mm	[Green]
gres smaltato - glazed gres	6 - 25 mm	[Green]
dekton	6 - 25 mm	[Green]
pietra - stone	6 - 25 mm	[Yellow]
granito - granite	6 - 25 mm	[Yellow]
marmo - marble	6 - 25 mm	[Yellow]
monocottura - single fired	6 - 25 mm	[Green]
cemento - beton	6 - 25 mm	[Green]
cotto - brick	6 - 25 mm	[Green]

Art.	Descrizione	Description		Euro
75B	Disco diamantato Ø 115mm foro 22,2 mm, spes.1,4 mm	Diamond disc Ø 115 mm hole 22,2 mm, thick 1,4 mm	10	19,00
75D	Disco diamantato Ø 125mm foro 22,2 mm, spes.1,4 mm	Diamond disc Ø 125 mm hole 22,2 mm, thick 1,4 mm	10	23,00

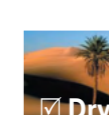
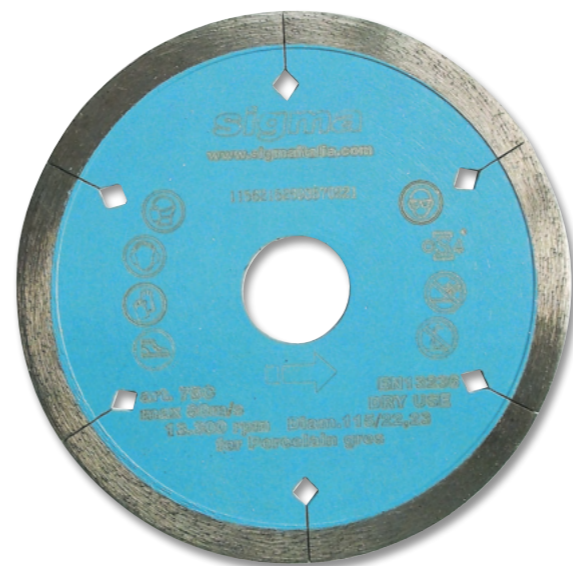

velocità - speed	[Progress bar]	
finitura - finish	[Progress bar]	
durata - life	350 linear mt *	
	spessore - thickness	resa - performance
gres porcellanato - porcelain	3 - 12 mm	[Green]
gres smaltato - glazed gres	3 - 12 mm	[Green]
dekton	3 - 12 mm	[Green]
pietra - stone	3 - 15 mm	[Yellow]
granito - granite	3 - 15 mm	[Yellow]
marmo - marble	3 - 15 mm	[Yellow]
monocottura - single fired	3 - 15 mm	[Green]
cemento - beton	3 - 15 mm	[Green]
cotto - brick	3 - 15 mm	[Green]

Art.	Descrizione	Description		Euro
75C	Disco diamantato Ø 115mm foro 22,2 mm, spessore 1,5	Diamond disc Ø 115mm hole 22.2 mm, thick 1.5 mm	10	23,50

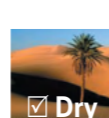

velocità - speed	[Progress bar]	
finitura - finish	[Progress bar]	
durata - life	1000 linear mt *	
	spessore - thickness	resa - performance
gres porcellanato - porcelain	6 - 25 mm	[Green]
gres smaltato - glazed gres	6 - 25 mm	[Green]
dekton	6 - 25 mm	[Green]
ceramica - ceramic	6 - 25 mm	[Green]
klinker	6 - 25 mm	[Green]
lapitec	6 - 25 mm	[Green]
monocottura - single fired	6 - 25 mm	[Green]
cotto - brick	6 - 25 mm	[Green]

NEW

Art.	Descrizione	Description		Euro
75E	Disco diamantato a lunga durata per taglio e molatura Ø 115mm foro 22,2 mm, spessore 1,7	Long life diamond disc for cutting and grinding Ø 115mm hole 22.2 mm, thick 1.7 mm	10	52,00



velocità - speed	[Progress bar]	
finitura - finish	[Progress bar]	
durata - life	400 linear mt **	
	spessore - thickness	resa - performance
gres porcellanato - porcelain	3 - 6 mm	[Yellow]
gres smaltato - glazed gres	3 - 6 mm	[Yellow]
dekton	3 - 6 mm	[Yellow]
vetro - glass	3 - 20 mm	[Green]
mosaico vetroso - glass	3 - 10 mm	[Green]

Art.	Descrizione	Description		Euro
75V	Disco diamantato Ø 100mm foro 22,2 mm, spes.1,2mm	Diamond disc Ø 100mm hole 22.2 mm, thick 1.2 mm	1	43,00



velocità - speed	[Progress bar]	
finitura - finish	[Progress bar]	
durata - life	400 linear mt *	
	spessore - thickness	resa - performance
gres porcellanato - porcelain	3 - 12 mm	[Green]
gres smaltato - glazed gres	3 - 12 mm	[Green]
dekton	3 - 12 mm	[Green]
pietra - stone	3 - 15 mm	[Yellow]
granito - granite	3 - 15 mm	[Yellow]
marmo - marble	3 - 15 mm	[Yellow]
monocottura - single fired	3 - 15 mm	[Green]
cemento - beton	3 - 15 mm	[Green]
cotto - brick	3 - 15 mm	[Green]



Art.	Descrizione	Description		Euro
75C3	Disco diamantato Ø 115mm foro 22,2 mm, spes.1,1 mm	Diamond disc Ø 115mm hole 22.2 mm, thick 1.1 mm	10	40,50

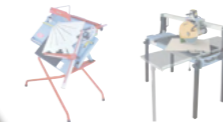

velocità - speed	[Progress bar]	
finitura - finish	[Progress bar]	
durata - life	500 linear mt *	
	spessore - thickness	resa - performance
gres porcellanato - porcelain	6 - 60 mm	[Green]
gres smaltato - glazed gres	6 - 60 mm	[Green]
dekton	6 - 60 mm	[Green]
pietra - stone	6 - 60 mm	[Yellow]
granito - granite	6 - 60 mm	[Yellow]
marmo - marble	6 - 60 mm	[Yellow]
monocottura - single fired	6 - 60 mm	[Green]
cemento - beton	6 - 60 mm	[Green]
cotto - brick	6 - 60 mm	[Green]

Art.	Descrizione	Description		Euro
60B	Disco diamantato Ø 200 foro 30, spessore 2.1 mm	Diamond disc Ø 200, 30 mm hole, 2.1 mm thick	1	105,00
79C	Disco diamantato Ø 250 foro 30, spessore 2.5 mm	Diamond disc Ø 250, 30 mm hole, 2.5 mm thick	1	125,00
74C	Disco diamantato Ø 300 foro 30, spessore 2.7mm	Diamond disc Ø 300, 30 mm hole, 2.7 mm thick	1	158,00

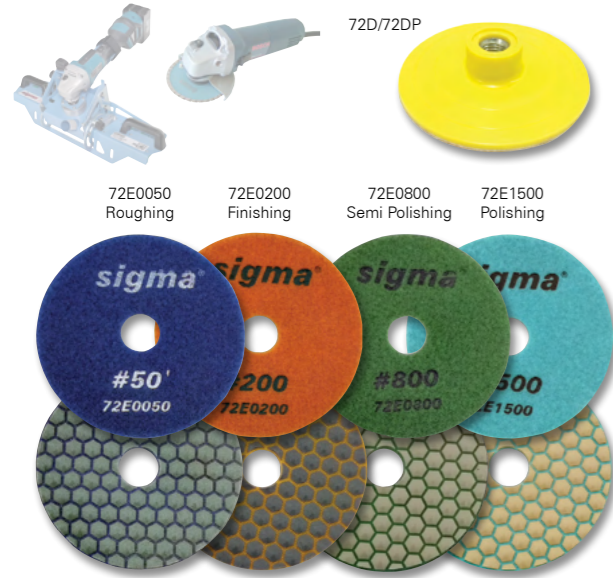

velocità di asportazione - grinding speed	
finitura - finish	
durata - life	
50 cm ³ porcelain gres	
rpm	
resa - performance	
gres porcellanato - porcelain	consigliati 4.000
gres smaltato - glazed gres	max 7.000
pietra - stone	
granito - granite	
marmo - marble	
monocottura-single fired	recommended 4.000
cemento - beton	max 7.000
cotto - brick	

Art.	Descrizione	Description	Euro
	Platorello Ø100 per traino mole	Pad Ø100 for grinding wheel	
72D	Attacco M14	M14 thread	1 10,00
	Mola diamantata Ø100 con velcro	Diamond Grinding wheel Ø100 - 4" with velcro	
72E0050	Grana 50 per sgrossatura	50-grit roughing	10 13,00
72E0200	Grana 200 per finitura	200-grit for finishing	10 13,00
72E0800	Grana 800 per lucidatura opaca	800-grit for semi-polishing	10 13,00
72E1500	Grana 1500 per lucidatura	1500-grit for polishing	10 13,00

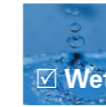
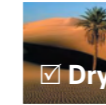
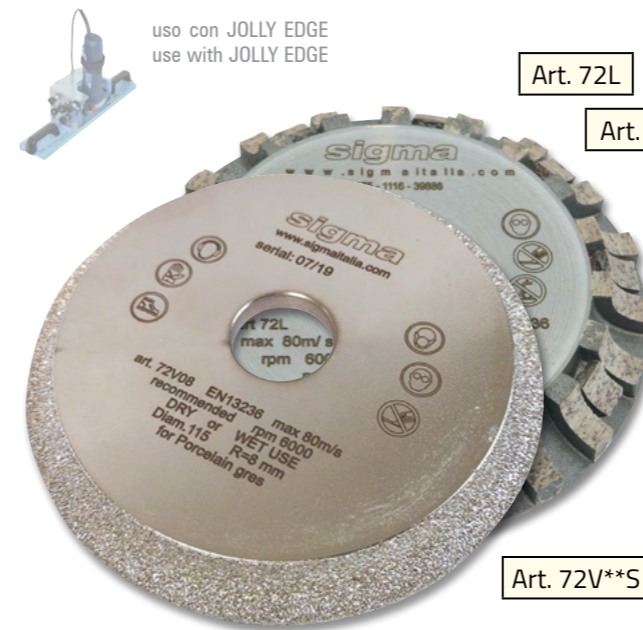

velocità di asportazione - grinding speed	
finitura - finish	
durata - life	
50 cm ³ porcelain gres	
rpm	
resa - performance	
gres porcellanato - porcelain	consigliati 6.000
gres smaltato - glazed gres	max 11.000
pietra - stone	
granito - granite	
marmo - marble	
monocottura-single fired	recommended 6.000
cemento - beton	max 11.000
cotto - brick	

Art.	Descrizione	Description	Euro
	Mola Diamantata VACUUM completo di art.100533 durata indicativa: 300 mt.	VACUUM Diamond Grinding Wheels complete with art.100533 indicative Life: 300 mt.	
72V06S	Ø 115 / 22,2 raggio 6	Ø 115 / 22,2 radius 6	1 215,00
72V08S	Ø 115 / 22,2 raggio 8	Ø 115 / 22,2 radius 8	1 202,00
72V10S	Ø 115 / 22,2 raggio 10	Ø 115 / 22,2 radius 10	1 228,00
	Mola Diamantata a LUNGA DURATA. Durata indicativa: 1000 mt.	LONG LIFE Diamond Grinding Wheels indicative Life: 1000 mt.	
72L	Ø 115 / 22,2 raggio 8	Ø 115 / 22,2 radius 8	1 329,00
72L10	Ø 115 / 22,2 raggio 10	Ø 115 / 22,2 radius 10	1 329,00

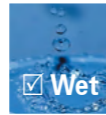
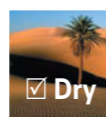

velocità di asportazione - grinding speed	
finitura - finish	
durata - life	
130 cm ³ porcelain gres	
rpm	
resa - performance	
gres porcellanato - porcelain	
gres smaltato - glazed gres	
pietra - stone	
granito - granite	
marmo - marble	
monocottura-single fired	
cemento - beton	
cotto - brick	

Art.	Descrizione	Description	Euro
72F060	Mola Diamantata Lamellare grana 60, Ø 115 mm, foro 22,2 (100 lamelle)	Lamellar Diamond Grinding Wheels, 60-grit, Ø 115mm hole 22.2, (100 flap)	5 49,50
72F120	Mola Diamantata Lamellare grana 120, Ø 115 mm, foro 22,2 (100 lamelle)	Lamellar Diamond Grinding Wheels, 120-grit, Ø 115mm hole 22.2, (100 flap)	5 49,50

NEW



Art.	Descrizione	Description	Euro
	Mola Professionale LUNGA DURATA per la rimozione della colla	LONG LIFE Professional FAST Glue Remover	
72A	Mola diamantata Ø 115 mm - 4,5" Hole 22,2 mm	Grinding Cup Ø 115 mm - 4,5" Hole 22,2 mm	1 44,50

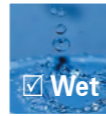
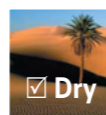
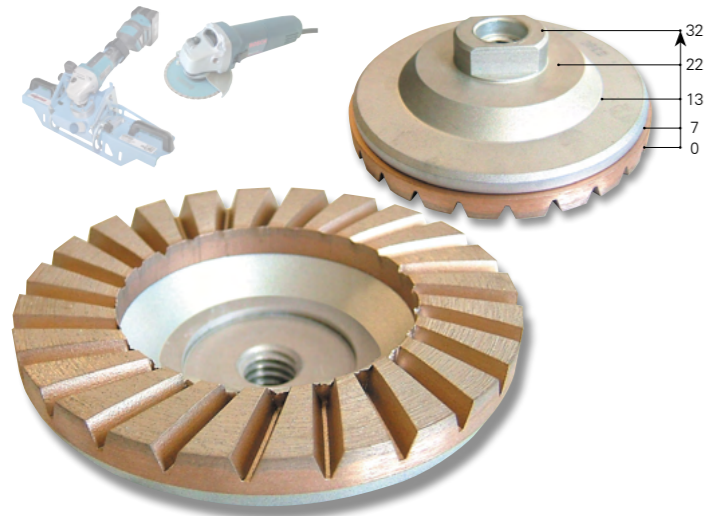

velocità di asportazione - grinding speed	
finitura - finish	
durata - life	
500 cm ³ porcelain gres	
rpm	
resa - performance	
gres porcellanato - porcelain	consigliati 6.000
gres smaltato - glazed gres	max 11.000
pietra - stone	
granito - granite	
marmo - marble	
monocottura-single fired	recommended 6.000
cemento - beton	max 11.000
cotto - brick	

Art.	Descrizione	Description	Euro
72	Mola Diamantata Ø 100 a LUNGA DURATA	LONG LIFE Diamond Grinding Wheels Ø 100	
72P	Attacco 5/8"11 UNC	Thread 5/8"11 UNC	1 169,00

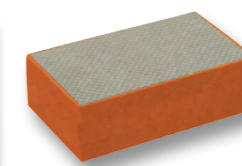

Art. 72H1

Art.	Descrizione	Description	Euro
72H1	Tampone diamantato Grana 120 per finitura a mano 93x58x27	Diamond pad for hand finishing; 120-grit; 93x58x27	10 18,50
100533	Stick per ravnivatura utensili diamantati cm. 21,5x10x5,5	Grindstone for dressing of diamond tools cm. 21,5x10x5,5	1 8,90
1073	Anello riduzione foro dischi 30 - 25,4	Reducing ring, Hole 30 - 25,4 for diamond disk	1 2,80

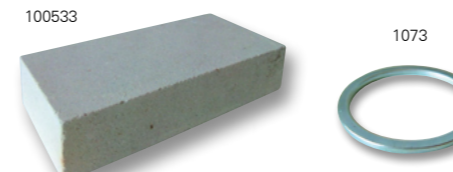

Frese diamantate attacco M14
Diamond drill bits with Threaded M14 attachment

NEW

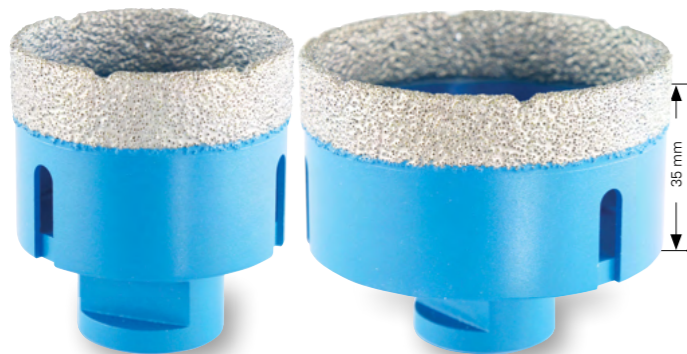
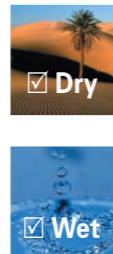

Art. 53G

Cera lubrificante per foratura a secco, consigliata per diametri da 6 a 12 mm
Usato durante la foratura aumenta la durata della fresa.

Cooling wax for dry drilling, recommended for diameters from 6 to 12 mm.
Using this during drilling increases the life of the drill bit.



velocità di asportazione - grinding speed	durata - life			
	manually / guided	rendimento - resa		
gres porcellanato - porcelain	0-15 / 35 mm			
gres smaltato - glazed gres	0-15 / 35 mm			
dekton	0-15 / 35 mm			
pietra - stone	0-15 / 35 mm			
granito - granite	0-15 / 35 mm			
marmo - marble	0-15 / 35 mm			
monocottura - single fired	0-15 / 35 mm			
cemento - beton	0-15 / 35 mm			
cotto - brick	0-15 / 35 mm			

Art.	Descrizione	Description	RPM	Euro
	FRESE DIAMANTATE "FAST" per foratura a secco o ad acqua Attacco: filettato M14	DIAMOND DRILL BITS "FAST" for dry or wet drilling Attach: Threaded M14	Velocità raccomandata Recommended speed	
53G	Cera di raffreddamento per foratura a secco 30 ml.	Cooling wax /gel for dry drilling 30 ml.	5	4,50
53006M	Fresa Ø mm 6	Drill Bit Ø 6 mm	6000	5 16,00
53008M	Fresa Ø mm 8	Drill Bit Ø 8 mm	6000	5 16,00
53010M	Fresa Ø mm 10	Drill Bit Ø 10 mm	6000	5 16,00
53012M	Fresa Ø mm 12	Drill Bit Ø 12 mm	6000	5 16,00
53020	Fresa Ø mm 20	Drill Bit Ø 20 mm	6000	5 18,00
53025	Fresa Ø mm 25	Drill Bit Ø 25 mm	6000	5 20,00
53030	Fresa Ø mm 30	Drill Bit Ø 30 mm	5000	5 22,00
53035	Fresa Ø mm 35	Drill Bit Ø 35 mm	4000	5 26,00
53040	Fresa Ø mm 40	Drill Bit Ø 40 mm	4000	5 29,00
53050	Fresa Ø mm 50	Drill Bit Ø 50 mm	4000	5 37,00
53060	Fresa Ø mm 60	Drill Bit Ø 60 mm	3000	5 44,00
53070	Fresa Ø mm 70	Drill Bit Ø 70 mm	3000	5 51,00



Frese diamantate attacco esagonale 9mm
Diamond drill bits with 9mm Hex attachment



Art. 53G

Cera lubrificante per foratura a secco, consigliata per diametri da 6 a 12 mm
Usato durante la foratura aumenta la durata della fresa.

Cooling wax for dry drilling, recommended for diameters from 6 to 12 mm.
Using this during drilling increases the life of the drill bit.



velocità di asportazione - grinding speed	durata - life			
	manually / guided	rendimento - resa		
gres porcellanato - porcelain	0-15 / 35 mm			
gres smaltato - glazed gres	0-15 / 35 mm			
dekton	0-15 / 35 mm			
pietra - stone	0-15 / 35 mm			
granito - granite	0-15 / 35 mm			
marmo - marble	0-15 / 35 mm			
monocottura - single fired	0-15 / 35 mm			
cemento - beton	0-15 / 35 mm			
cotto - brick	0-15 / 35 mm			

Art.	Descrizione	Description	RPM	Euro
	FRESE DIAMANTATE "FAST" per foratura a secco o ad acqua	DIAMOND DRILL BITS "FAST" for dry or wet drilling	Velocità raccomandata Recommended speed	
53G	Cera di raffreddamento per foratura a secco 30ml.	Cooling wax /gel for dry drilling 30 ml.	5	4,50
53006	Fresa Ø mm 6	Drill Bit Ø 6 mm	1000	10 16,00
53008	Fresa Ø mm 8	Drill Bit Ø 8 mm	1000	10 16,00
53010	Fresa Ø mm 10	Drill Bit Ø 10 mm	1000	10 16,00
53012	Fresa Ø mm 12	Drill Bit Ø 12 mm	1000	10 16,00

Allargatore diamantato
Diamond enlarger

Art. 54030



NEW

Diametro 25mm per allargare fori o creare aperture.
25 mm Ø to enlarge holes or make pockets



Allargatore diamantato "FAST"
Grazie al doppio diametro diamantato ed alla zona raggiata è possibile allargare, sagomare, rifinire fori e tasche, arrotondare e smussare gli spigoli della piastrella.

Diamond Enlarger "FAST"
Thanks to the double diamond diameter and to the radiated zone it's possible to enlarge, shape and finish holes and pockets, round and bevel the angles of the tile.

Art.	Descrizione	Description	RPM	Euro
	FRESE DIAMANTATE "FAST" per foratura a secco o ad acqua Attacco: filettato M14	DIAMOND DRILL BITS "FAST" for dry or wet drilling Attach: Threaded M14	Velocità raccomandata Recommended speed	
54030	Allargatore diamantato "FAST" per sagonatura a secco o ad acqua	Diamond enlarger "FAST" for dry or wet enlarging	6000	1 27,00

Art. 42E

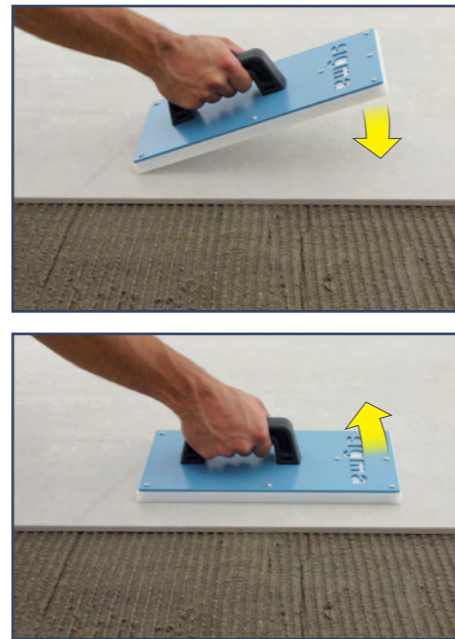

Fratteggio Battipiatrelle 16x33 cm, specifico per la corretta espulsione dell'aria da sotto la piastrella.

Beat Tile Trowel 16x33 cm, specific for the correct expulsion of air from under the tile.

Art. 49E

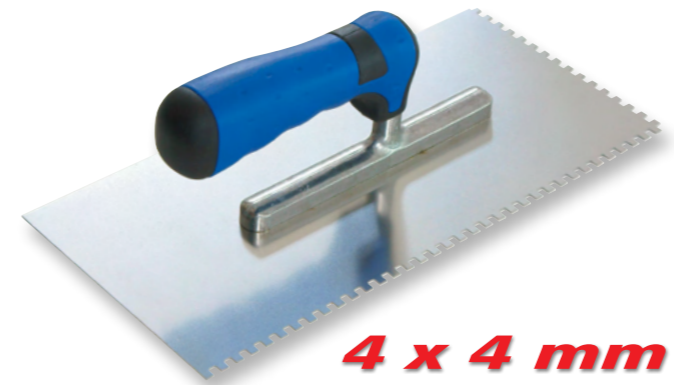

Art. 49H

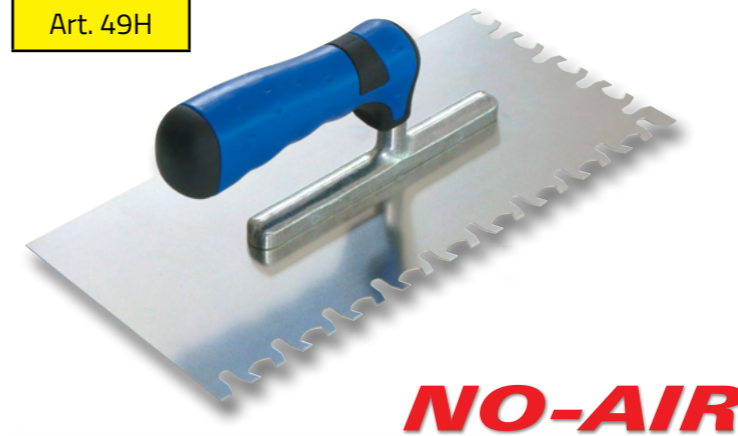

Art.	Descrizione	Description	☞	Euro
51G	Gruppo ventose MOVE	MOVE Suction Cups	1	155,00
49H	Spatole per colla INOX con impugnatura anatomica morbida, 28x13 cm dente No-Air .	Stainless steel trowel with soft anatomical handle, 28x13 cm No-Air teeth.	30	15,10
49E	Spatole per colla INOX con impugnatura anatomica morbida, 28x13 cm dente 4x4 mm.	Stainless steel trowel with soft anatomical handle, 28x13 cm 4x4 mm teeth.	30	12,90
42E	Fratteggio Battipiatrelle 16x33 cm. Fondo antisegno kg. 2	Beat Tile trowel 16x33 cm. Stain Free kg.2	1	49,00
Vendita a confezioni intere		Sold in full packs only	☞	

Art. 49H Spatola per la corretta stesura della colla **SENZA ARIA**, particolarmente indicata per **grandi lastre**, (sezione equivalente 11,5x11,5 cm). Per la doppia spalmatura combinare con Art. 49E (dente 4x4 mm).

Art. 49H **NO-AIR** stainless steel trowel for glue applying, indicated for **Large format tiles** (equivalent section 11,5x11,5 mm). For double buttering, combine with Art. 49E (4x4 mm tooth).

Art. 51G

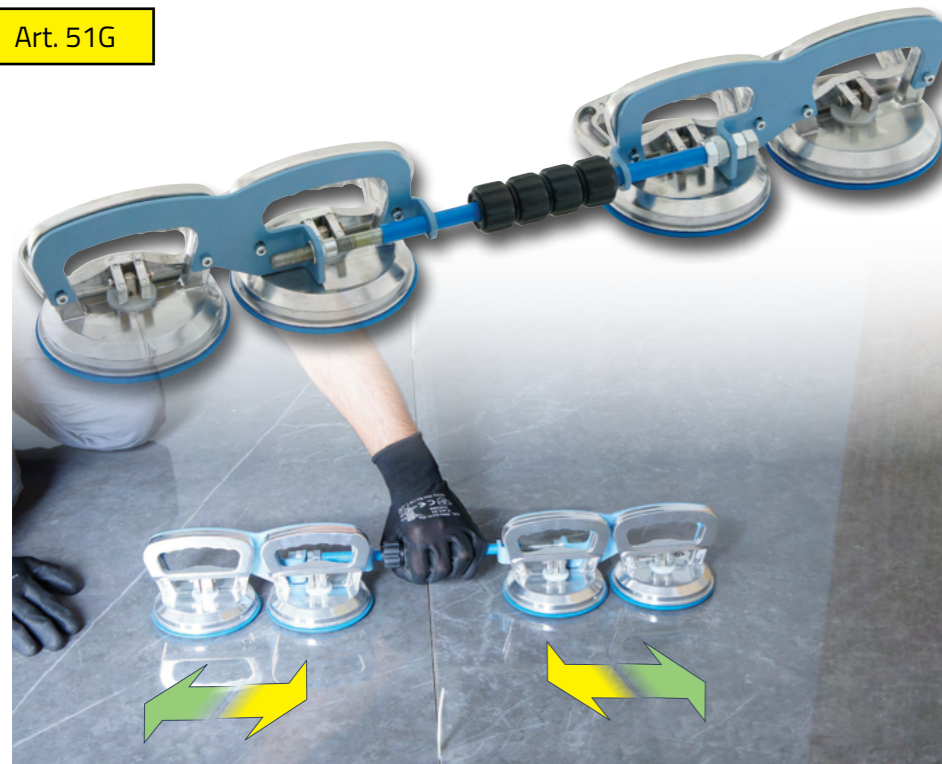

Il Gruppo ventose MOVE è indispensabile per il corretto avvicinamento delle lastre di grande formato grazie alle quattro ventose antimacchia, a forte tenuta, anche su materiali ruvidi.

The MOVE suction cups is indispensable for the correct approach of the large format tiles, thanks to the four strong stain-free suction cups adherents also on rough materials



Scegli la tua configurazione
Choose your configuration

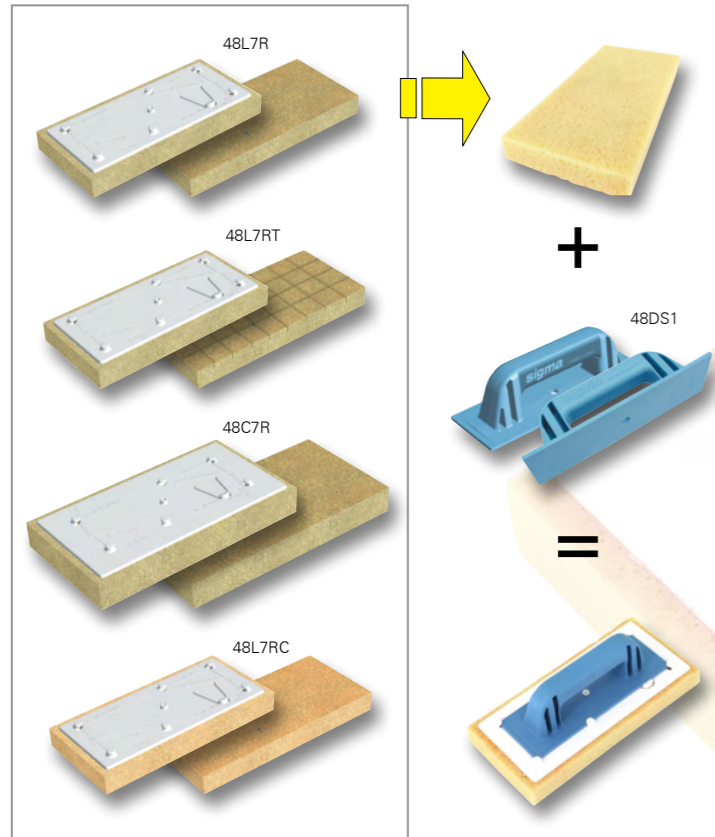

Art.	Descrizione	Description	📦	Euro
48L7R	Spugna ad alto assorbimento 30x14x3 cm.	High absorbtion sponge 30x14x3 cm.	30	6,50
48L7RT	Spugna ad alto assorbimento con intagli 30x14x3 cm.	High absorbtion sponge with cuts 30x14x3 cm.	30	7,10
48C7R	Spugna ad alto assorbimento 34x18x4 cm.	High absorbtion sponge 34x18x4 cm.	15	9,60
48L7RC	Spugna cellulosa per resina epossidica 30x14x3 cm.	Cellulose sponge float for epoxy resin 30x14x3 cm.	30	14,50
48DS1	Impugnatura intercambiabile per Art. 48C7R - 48L7R - 48L7RT - 48L7RC	Interchangeable handle for Art. 48C7R - 48L7R - 48L7RT - 48L7RC	10	3,00
Vendita a confezioni intere			Sold in full packs only	

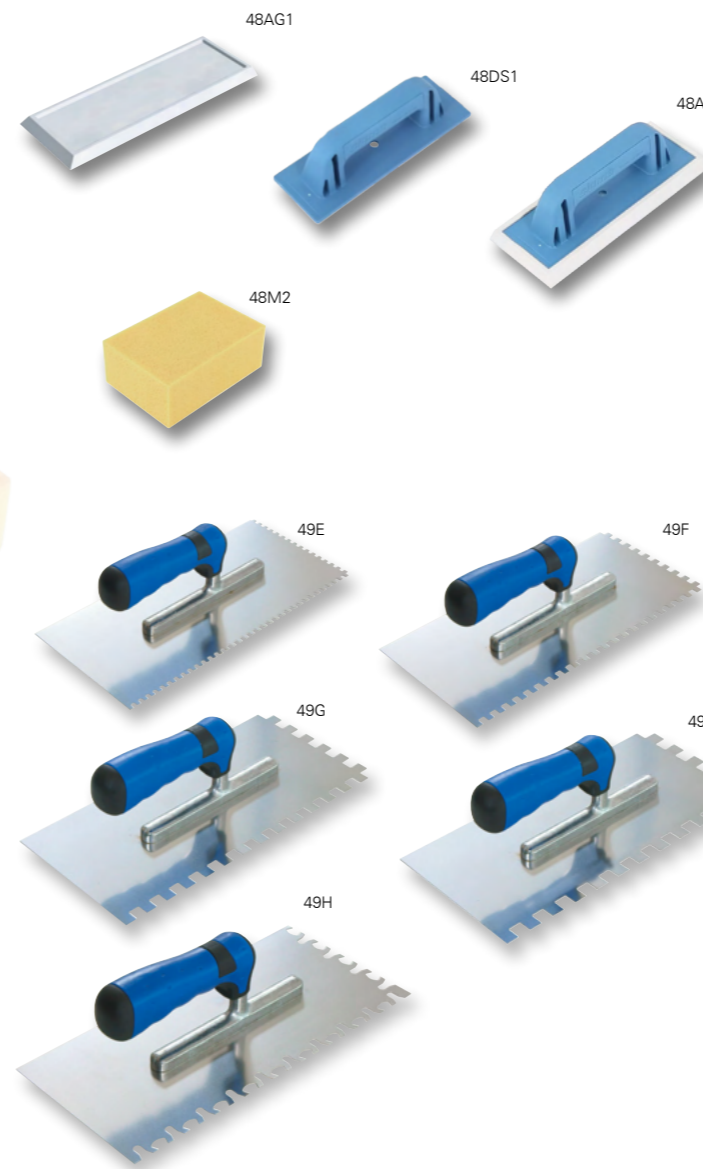
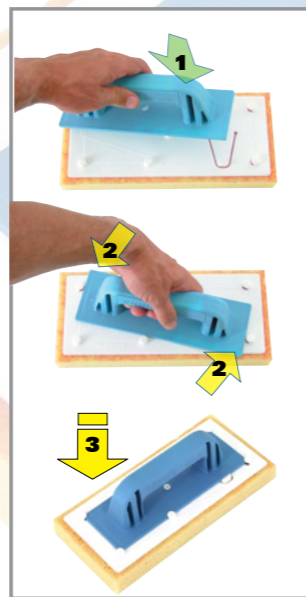

Art.	Descrizione	Description	📦	Euro
48A7	Frattazzo 25x10 cm. con gomma di durezza media (50 shore) per stuccatura doppia angolazione 55°-70°	Rubber grout float 25x10cm with medium hardness (50 shore). Double angle 55°-70°	30	8,60
48DS1	Impugnatura intercambiabile per Art. 48A7	Interchangeable handle for Art. 48A7	10	3,00
48AG1	Gomma bianca ricambio per Art. 48A7 55°-70° 50 sh	Spare part rubber for Art. 48A7 55°-70° 50 sh	10	4,60
48M2	Spugna ad alto assorbimento cm. 18x12x6	High absorption sponge 18x12x6 cm.	50	2,40
Vendita a confezioni intere			Sold in full packs only	

Art.	Descrizione	Description	📦	Euro
49E	Spatole per colla INOX con impugnatura anatomica morbida, 28x13 cm dente 4x4 mm.	Stainless steel trowel with soft anatomical handle, 28x13 cm 4x4 mm teeth.	30	12,90
49F	Spatole per colla INOX con impugnatura anatomica morbida, 28x13 cm dente 6x6 mm.	Stainless steel trowel with soft anatomical handle, 28x13 cm 6x6 mm teeth.	30	12,90
49G	Spatole per colla INOX con impugnatura anatomica morbida, 28x13 cm dente 10x10 mm.	Stainless steel trowel with soft anatomical handle, 28x13 cm 10x10 mm teeth.	30	12,90
49L	Spatole per colla INOX con impugnatura anatomica morbida, 28x13 cm dente 12x12 mm.	Stainless steel trowel with soft anatomical handle, 28x13 cm 12x12 mm teeth.	30	12,90
49H	Spatola INOX per la corretta stesura della colla SENZA ARIA , particolarmente indicata per Slim-tiles, piastrelle di grandi dimensioni e mosaico (sezione equivalente 11,5x11,5 cm), con impugnatura anatomica	Stainless steel trowel for correct AIR-FREE thinset application, particularly suitable for Slim-tiles, large tiles dimensions and mosaic (section equivalent 11.5x11.5 cm), with soft anatomical handle	30	15,10
Vendita a confezioni intere			Sold in full packs only	

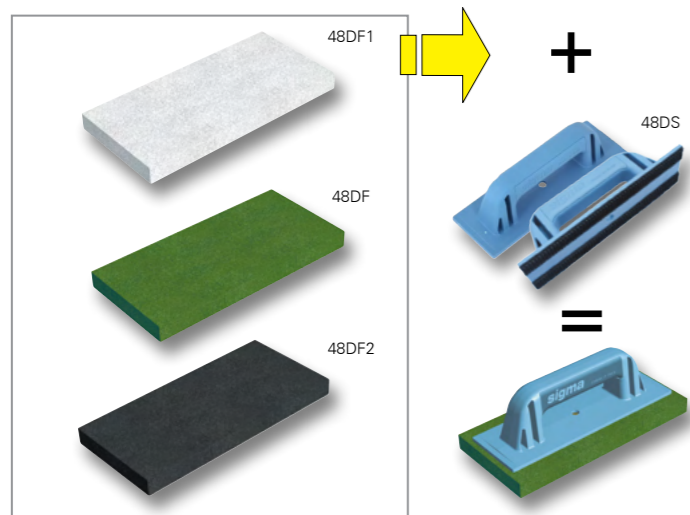

Art.	Descrizione	Description	📦	Euro
48DF1	Feltro bianco, delicato 25x12 cm. ricambio per Art.48D7	White felt, delicated 25x12 cm. spare for Art.48D7	12	2,70
48DF	Feltro verde, medio 25x12 cm. ricambio per Art.48D7	Medium green felt 25x12 cm. spare for Art.48D7	12	2,70
48DF2	Feltro nero, forte 25x12 cm. ricambio per Art.48D7	Strong black grout float 25x12 cm. Spare for Art. 48D7	12	2,70
48DS	Impugnatura intercambiabile con velcro per feltro	Interghangable handle with velcro for growth float	12	6,70
Vendita a confezioni intere			Sold in full packs only	

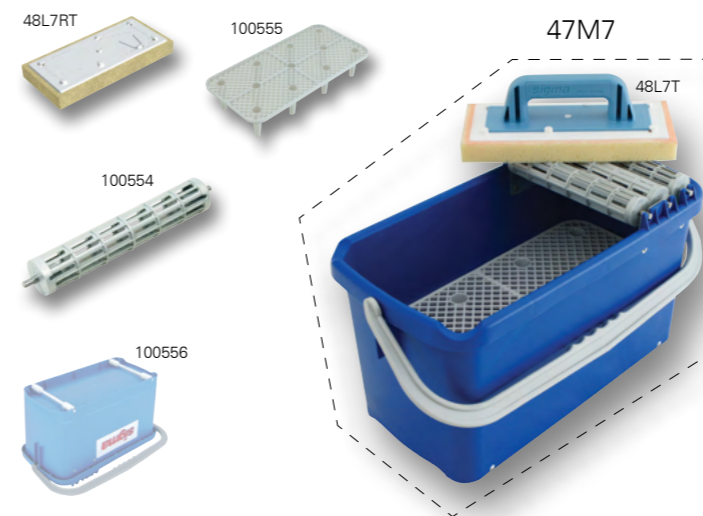

Art.	Descrizione	Description	📦	Euro
47M7	Vasca lavaggio-strizzatura (dim. 56x29x30) con 3 rulli perno acciaio, manico e ruote, completa di frattazzo spugna (Art.48L7T).	Wash bucket (dim.56x29x30) with 3 steel pin rollers, handle and wheels, complete with sponge float (Art.48L7T)	1	109,00
48L7RT	Ricambio per frattazzo, con intagli Art.48L7T 30x14x3 cm.	Spare sponge float with cuts 30x14x3cm for Art.48L7T	30	7,10
100554	Rullo strizzatore forato, perno acciaio per art. 47M7	Drilled wringing roller, with steel pin for Art.47M7	3	11,50
100556	Rullo ruota singolo per art. 47M7 - 47M8	Single Roller-wheel for art. 47M7 - 47M8	2	4,50
100555	Griglia per 47M7 - 47M8	Grid for 47M7 - 47M8	1	29,00
Vendita a confezioni intere			Sold in full packs only	



Art.	Descrizione	Description	Euro
51L	Ventosa doppia in alluminio Ø120 a forte bloccaggio, specifica per materiali ruvidi. Portata max 80kg (40 kg a norme CE) gomma antimacchia	Double Alluminium Suction Cup Ø120 mm Strong locking. Specific for rough materials. Capacity max 80kg (40 kg to CE rules) Stain-free rubber	1 32,50
51B	Ventosa in alluminio Ø120 a forte bloccaggio, anche per materiali ruvidi. Portata max 40kg (10 kg a norme CE) gomma antimacchia	Alluminium Suction Cup Ø120 mm Strong locking. Also for rough materials. Capacity max 40kg (10 kg to CE rules) Stain-free rubber	10 20,90
51F	Gomma per ventosa 51B-D-A-L Ø120	Rubber plate for suction cup 51B-D-A-L Ø120	1 14,70
51P1	Ventosa a pompa Ø150 con valigia, ottima anche per materiali ruvidi. Portata max 90kg (45kg a norme CE) gomma antimacchia	Pump Suction Cup Ø150 mm Also with suitcase, excellent for rough materials. Capacity max 90kg (45 kg to CE rules) Stain-free rubber	1 129,00
51F1	Filtro Ø 11 per Ventosa a pompa Ø150	Filter Ø 11 for Pump Suction Cup Ø150 mm	1 2,80
10518	Protezione per la gomma delle ventose Ø150 (51P1)	Protection for the rubber of Ø150 suction cups (51P1)	1 5,10
50	Frusta mescolatore Diam.120 mm per trapano	Whisk mixer D.120 mm, hexagonal junction for electric drill	10 8,50
42	Mazzetto gomma antisegno 500 gr.	Rubber hammer Stain-Free 500 gr.	6 9,90
42A	Mazzetto gomma antisegno 1000 gr.	Rubber hammer Stain-Free 1000 gr.	6 15,50
	SEPARATORE universale	Universal SEPARATOR	
41E	O>15mm	O>15mm	1 19,90
41D	O>20mm	O>20mm	1 44,00
Vendita a confezioni intere		Sold in full packs only	

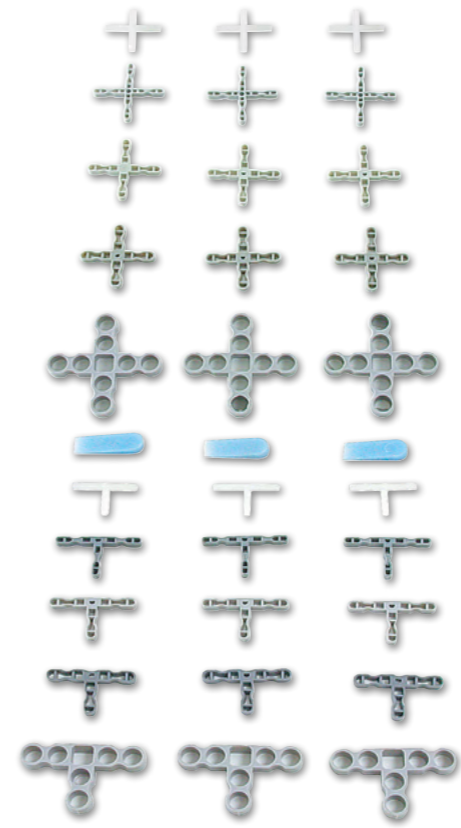

Art.	Descrizione	Description	Euro
	Distanziatori per piastrelle sacchetti da 500 pezzi	Tiling Spacers bags of 500 pieces	
40-X1	500 pz. a X spessore mm.1 - H.4	500 pcs. X thickness mm.1 - H.4	40 3,80
40-X2	500 pz. a X spessore mm.2 - H.4	500 pcs. X thickness mm.2 - H.4	40 3,80
40-X3	500 pz. a X spessore mm.3 - H.4,5	500 pcs. X thickness mm.3 - H.4,5	40 3,80
40-X5	500 pz. a X spessore mm.5 - H.4,5	500 pcs. X thickness mm.5 - H.4,5	40 3,90
40-X10	500 pz. a X spessore mm.10 - H.8	500 pcs. X thickness mm.10 - H.8	10 12,50
40-C	500 Spessori a Cuneo 0-5 mm.	500 Tiling Wedges 0-5 mm.	40 3,70
40-T1	500 pz. a T spessore mm.1 - H.4	500 pcs. T thickness mm.1 - H.4	40 3,80
40-T2	500 pz. a T spessore mm.2 - H.4	500 pcs. T thickness mm.2 - H.4	40 3,80
40-T3	500 pz. a T spessore mm.3 - H.4,5	500 pcs. T thickness mm.3 - H.4,5	40 3,80
40-T5	500 pz. a T spessore mm.5 - H.4,5	500 pcs. T thickness mm.5 - H.4,5	40 3,90
40-T10	500 pz. a T spessore mm.10 - H.8	500 pcs. T thickness mm.10 - H.8	10 11,50
Vendita a confezioni intere Distanziatori rimovibili non soggetti a DoP-dichiarazione di prestazione (distanziatori da asportare a fine lavoro se si vuol garantire la robustezza della stuccatura)		Sold in full packs only Removable spacers not subject to DoP (Spacer to be removed after work if you want to ensure the robustness of grouting)	



Art.	Descrizione	Description	Euro
46	Ginocchiere profes. alta qualità U.S.A. avvolgenti con elastici in silicone (paio)	Professional knee wrap high quality U.S.A.with Silicone rubber strap (pair)	1 35,50
46A	Ginocchiere professionali monoblocco alta protezione	Professional one-piece high-protection Knee Pads	1 18,90
46C1	Set di 8 bottoni (4 lunghi +4 corti) per Art. 46	Set of 8 buttons (4+4) for Art.46	1 6,90
46D1	Set di 4 elastici al silicone per Art. 46 (4pz)	Set of 4 silicone rubber strap for Art.46 (4pcs)	1 12,80
Vendita a confezioni intere		Sold in full packs only	

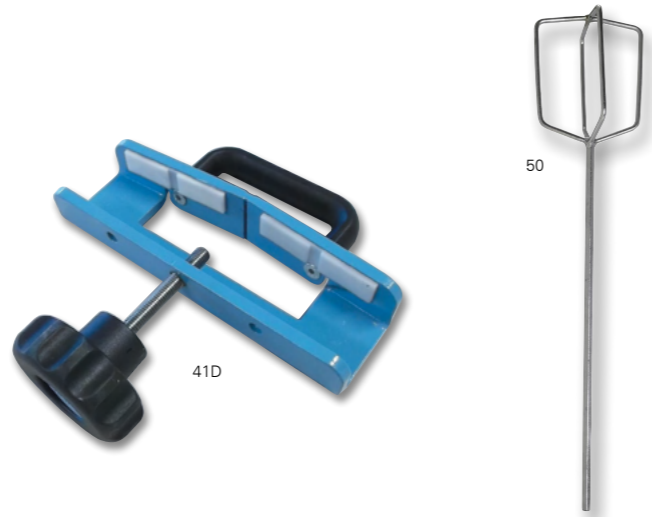

Art.	Descrizione	Description	Euro
	Materiale espositivo (condizioni particolari a richiesta)	Exhibition materials (special conditions on request)	
107210a	Targa adesiva trasparente 500x200 mm	Transparent adhesive label 500x200 mm	1 12,00
107210b	Banner in tela 2000x800 mm	Banner in cloth 2000x800 mm	1 29,50
95E	ESPOSITORE VERTICALE a piani, altezza cm.200 con pannello accessori a 10 posti + 4 posti taglia piastrelle Art. -3L*-4B*-4C*-4D*-4E*-4F*	VERTICAL DISPLAY whith shelves, height cm.200 with accessory panel whith 10 places + 4 places for tilecutter Art. -3L*-4B*-4C*-4D*-4E*-4F*	1 370,00

Le caratteristiche e le indicazioni descritte sul catalogo s'intendono approssimative, riservandoci di apportare tutte quelle modifiche che a nostro giudizio costituiscono migliorie, senza che ciò possa giustificare reclamo da parte committente.

All machine features and indications given in the catalogue are purely indicative. The manufacturer reserves the right to make any changes whatsoever at any time with the aim of improving the machines. In no circumstances shall such changes justify complaints on the part of customers.

sigma di Ambrogiani S. & c. s.a.s.

Via Gagliani,4 47814 Bellaria Igea Marina (RN) Italia

Tel. +39 0541 330103

C.F.-P.I.-ID code: IT 01085360400 Fatt.Elettr.: mj1oynu

E-Mail: info@sigmaitalia.com Internet: <https://www.sigmaitalia.com>

CATALOG - PRICE LIST

valid from 15-09-2023